



রুরাল পাওয়ার কোম্পানী লিমিটেড

RURAL POWER COMPANY LIMITED

TENDER DOCUMENT (INTERNATIONAL)

- Name of Tender Pkg-1** : Procurement of Air Filters of GT and Generator for Mymensingh Power Station.
- Name of Lot-1 of Pkg-1** : Procurement of Air Filters of GT and Generator for Mymensingh Power Station.
- Name of Tender Pkg-2** : Procurement of Bearings and Hardware of GT for Mymensingh Power Station.
- Name of Lot-1 of Pkg-2** : Procurement of GT Bearings for Mymensingh Power Station.
- Name of Lot-2 of Pkg-2** : Procurement of GT Hardware for Mymensingh Power Station.
- Invitation Reference** : Pur-008(FG/MPS/OTM)/2020-2021
Date : 24-September-2020

Corporate Office

House: 19, Road: 1/B, Sector: 09,
Uttara Model Town, Dhaka-1230,
Bangladesh.

Table of Contents

Section 1. Instructions to Tenderers.....	1
A. General.....	1
1. Scope of Tender	1
2. Interpretation.....	1
3. Source of Funds	1
4. Corrupt, Fraudulent, Collusive or Coercive Practices.....	2
5. Eligible Tenderers	3
6. Eligible Goods and Related Services.....	4
7. Site Visit	4
B. Tender Document.....	4
8. Tender Document: General.....	4
9. Clarification of Tender Documents.....	5
10. Pre-Tender Meeting	5
11. Addendum to Tender Documents	5
C. Qualification Criteria	6
12. General Criteria	6
13. Litigation History	6
14. Experience Criteria	6
15. Financial Criteria	7
16. Appointment of Subcontractor	7
D. Tender Preparation.....	7
17. Only One Tender	7
18. Cost of Tendering	7
19. Issuance and Sale of Tender Document.....	7
20. Language of Tender	8
21. Contents of Tender	8
22. Alternatives	9
23. Tender Prices, Discounts and Price adjustment	9
24. Tender Currency	12
25. Documents Establishing the Conformity of the Goods and Related services.....	12
26. Documents Establishing Qualifications of the Tenderer.....	12
27. Validity Period of Tender	12
28. Extension of Tender Validity and Tender Security	13
29. Tender Security	13
30. Form of Tender security	13
31. Authenticity of Tender Security.....	14
32. Return of Tender Security	14
33. Forfeiture of Tender Security.....	14
34. Format and Signing of Tender	14
E. Tender Submission.....	15
35. Sealing, Marking and Submission of Tender	15
36. Deadline for Submission of tenders.....	16
37. Late tender	16
38. Modification, Substitution or Withdrawal of Tenders	16
39. Tender Modification.....	16
40. Tender Substitution.....	16
41. Withdrawal of Tender.....	16
F. Tender Opening and Evaluation.....	16
42. Tender Opening.....	16
43. Evaluation of Tenders	18
44. Evaluation process.....	18
45. Preliminary Examination	18
46. Technical Examinations & Responsiveness.....	19

47. Clarification on Tender	20
48. Restrictions on the Disclosure of Information Relating to the Procurement Process	20
49. Correction of Arithmetical Errors	21
50. Conversion to Single Currency	21
51. Domestic Preference	21
52. Financial Evaluation	22
53. Assessing the Price of Unpriced Items	23
54. Evaluation of Domestic Preference	23
55. Price Comparison	24
56. Negotiation	24
57. Post-qualification	24
58. Rejection of All Tenders	25
59. Informing Reasons for Rejection	25
G. Contract Award.....	25
60. Award Criteria	25
61. Purchaser's Right to Vary Quantities.....	26
62. Notification of Award	26
63. Performance Security	26
64. Form and Time Limit for furnishing of Performance security	26
65. Validity of Performance Security	27
66. Authenticity of performance Security	27
67. Contract Signing	27
68. Publication of Notification of Award of Contract.....	27
69. Debriefing of Tenderers	27
70. Right to Complain	28
Section 2. Tender Data Sheet	29
A. General.....	29
B. Tender Document.....	30
C. Qualification Criteria	30
D. Preparation of Tender	31
E. Submission of Tender	32
F. Opening and Evaluation of Tenders.....	33
G. Award of Contract	33
Section 3. General Conditions of Contract	34
1. Definitions	34
2. Contract Documents.....	35
3. Corrupt, Fraudulent, Collusive or Coercive Practices	35
4. Interpretation.....	36
5. Documents Forming the Contract in order of precedence.....	37
6. Eligibility	37
7. Governing Language	37
8. Governing Law	37
9. No fees/Gratuities	37
10. Use of Contract Documents & Information	38
11. Communications & Notices	38
12. Trademark, Patent and Intellectual Property Rights	38
13. Copyright	38
14. Assignment	38
15. Sub contracting.....	Error! Bookmark not defined.
16. Supplier's Responsibilities	38
17. Purchaser's Responsibilities	39
18. Scope of Supply.....	39
19. Amendment to Order	39
20. Instances When Amendment to Order May be Issued.....	40

21. Adjustments in Contract Price and/or Delivery Schedule in Amendment to Order	40
22. Packing and Documents	40
23. Delivery and Documents	41
24. Acceptance	41
25. Contract Price	41
26. Transportation	41
27. Terms of Payment	42
28. Insurance	42
29. Taxes and Duties	42
30. Performance Security	42
31. Specifications and Standards	43
32. Inspections and Tests	43
33. Warranty	44
34. Delays in Delivery and Extensions of Time	45
35. Liquidated Damages	45
36. Limitation of Liability	45
37. Change in Laws and Regulations	46
38. Definition of Force Majeure	46
39. Notice of Force Majeure	46
40. Duty to Minimise Delay	47
41. Consequences of Force Majeure	47
42. Termination for Default	47
43. Termination for insolvency	48
44. Termination for Convenience	48
45. Procedures for Termination of Contracts	49
46. Contract Amendment	49
47. Settlement of Disputes	50
Section 4. Particular Conditions of Contract	Error! Bookmark not defined.
Section 5. Tender and Contract Forms	Error! Bookmark not defined.
Tender Submission Letter (Form PG4 – 1)	57
Tenderer Information Sheet (Form PG4-2)	60
Price Schedule for Goods (Form PG4-3A)	62
Price Schedule for Goods (Form PG4-3B)	Error! Bookmark not defined.
Price Schedule for Goods (Form PG4-3C)	63
Price and Completion Schedule - Related Services (Form PG4-3D).....	71
Specifications Submission and Compliance Sheet (Form PG4-4) .	Error! Bookmark not defined.
Manufacturer’s Authorisation Letter (Form PG4 - 5).....	75
Bank Guarantee for Tender Security (Form PG4 – 6).....	76
Notification of Award (Form PG4 - 7)	77
Contract Agreement (Form PG4 - 8)	78
Bank Guarantee for Performance Security (Form PG4 – 9).....	79
Bank Guarantee for Advance Payment (Form PG4 – 10)	80
Section 6. Schedule of Requirements.....	Error! Bookmark not defined.
Section 7. Technical Specifications	Error! Bookmark not defined.
Section 8. Drawings.....	96

Section 1. Instructions to Tenderers

A. General

- 1. Scope of Tender**
- 1.1 The Purchaser named in the Tender Data Sheet (TDS) (hereinafter referred to as the “Purchaser”) wishes to issues these Tender Documents for the supply of Goods, and Related Services incidental thereto, as specified in the TDS and as detailed in Section 6: Schedule of Requirements.
- 1.2 The name of the Tender and the number and identification of its constituent lot(s) are stated in the TDS.
- 1.3 The successful Tenderer will be required to complete the delivery of the goods and related services (when applicable) as specified in the GCC Clause **18**.
- 2. Interpretation**
- 2.1 Throughout this Tender Document
- (a) the term “in writing” means communication written by hand or machine duly signed and includes properly authenticated messages by facsimile or electronic mail;
 - (b) if the context so requires, singular means plural and vice versa; and
 - (c) “day” means calendar days unless otherwise specified as working days;
 - (d) "Tender Document ", means the Document provided by a Purchaser to a Tenderer as a basis for preparation of its Tender;
 - (e) "Tender ", depending on the context, means a Tender submitted by a Tenderer for delivery of Goods and Related Services to a Purchaser in response to an Invitation for Tender ;
- 3. Source of Funds**
- 3.1 The Purchaser has been allocated public funds from the source as indicated in the TDS and intends to apply a portion of the funds to eligible payments under the contract for which this Tender Document is issued.
- 3.2 For the purpose of this provision, “public funds” means any funds allocated to a Purchaser under Government budget, or loan, grants and credits placed at the disposal of a Purchaser through the Government by the development partners or foreign states or organizations.
- 3.3 Payments by the development partner, if so indicated in the TDS, will be made only at the request of the Government and upon approval by the development partner in accordance with the applicable Loan/Credit/Grant Agreement, and will be subject in all respects to the terms and conditions of that Agreement.

4. Corrupt, Fraudulent, Collusive or Coercive Practices

- 4.1 The Government requires that Procuring Entities, as well as Tenderers shall observe the highest standard of ethics during implementation of procurement proceedings and the execution of Contracts under public funds.
- 4.2 The Government requires that Procuring Entities, as well as Tenderers and Suppliers shall, during the Procurement proceedings and the execution of Contracts under public funds, ensure-
- (a) strict compliance with the provisions of Section 64 of the Public Procurement Act 2006 (Act 24 of 2006);
 - (b) abiding by the code of ethics as mentioned in the Rule 127 of the Public Procurement Rules, 2008;
 - (c) that neither it's any officer nor any staff or any other agents or intermediaries working on its behalf engages in any practice as detailed in ITT Sub Clause 4.3.
- 4.3 For the purposes of ITT Sub-clause 4.2 the terms set forth as bellows:
- (a) **corrupt practice** means offering, giving or promising to give, receiving, or soliciting, either directly or indirectly, to any officer or employee of a Purchaser or other public or private authority or individual, a gratuity in any form; employment or any other thing or service of value as an inducement with respect to an act or decision or method followed by a Purchaser in connection with a Procurement proceeding or contract execution;
 - (b) **fraudulent practice** means the misrepresentation or omission of facts in order to influence a decision to be taken in a Procurement proceeding or Contract execution;
 - (c) **collusive practice** means a scheme or arrangement between two (2) or more Persons, with or without the knowledge of the Purchaser, that is designed to arbitrarily reduce the number of Tenders submitted or fix Tender prices at artificial, noncompetitive levels, thereby denying a Purchaser the benefits of competitive price arising from genuine and open competition; or
 - (d) **coercive practice** means harming or threatening to harm, directly or indirectly, Persons or their property to influence a decision to be taken in a Procurement proceeding or the execution of a Contract, and this will include creating obstructions in the normal submission process used for Tenders.
- 4.4 Should any corrupt, fraudulent, collusive or coercive practice of any kind come to the knowledge of the Purchaser, it will, in the first place, allow the Tenderer to provide an explanation and shall, take actions only when a satisfactory explanation is not received. Such exclusion and the reasons thereof, shall be recorded in the record of the procurement proceedings and promptly communicated to the Tenderer concerned. Any communications between the Tenderer and the Purchaser related to matters of alleged fraud or corruption shall be in writing.

- 4.5 If corrupt, fraudulent, collusive or coercive practices of any kind determined by the Purchaser against any Tenderer alleged to have carried out such practices, the Purchaser shall -
- (a) exclude the concerned Tenderer from further participation in the particular Procurement proceeding; or
 - (b) reject any recommendation for award that had been proposed for that concerned Tenderer or;
 - (c) declare, at its discretion, the concerned Tenderer to be ineligible to participate in further Procurement proceedings, either indefinitely or for a specific period of time.
- 4.6 The Tenderer shall be aware of the provisions on corruption, fraudulence, collusion and coercion in Section 64 of the Public Procurement Act, 2006 and Rule 127 of the Public Procurement Rules, 2008 and others as stated in GCC Clause 3.

5. Eligible Tenderers

- 5.1 This Invitation for Tenders is open to eligible Tenderers from all countries, except for any specified in the TDS. A Tenderer will be eligible if it is a citizen, or is constituted, registered and operates in conformity with the provisions of the laws of that country.
- 5.2 A Tenderer may be a physical or juridical individual or body of individuals, or company, association invited to take part in public procurement or seeking to be so invited or submitting a Tender in response to an Invitation for Tenders.
- 5.3 Government-owned enterprises in Bangladesh shall be eligible only if they can establish that they (i) are legally and financially autonomous, (ii) operate under commercial law, and (iii) are not a dependent agency of the Purchaser.
- 5.4 Tenderers shall have the legal capacity to enter into the Contract. A Tenderer that is under a declaration of ineligibility by the Government of Bangladesh in accordance with applicable laws at the date of the deadline for Tender submission or thereafter shall be disqualified.
- 5.5 Tenderers and all parties constituting the Tenderer shall not have a conflict of interest pursuant to Rule 55 of the Public Procurement Rules, 2008.
- 5.6 Tenderers in its own name or its other names or also in the case of its Persons in different names, shall not be under a declaration of ineligibility for corrupt, fraudulent, collusive or coercive practices as stated under ITT Sub Clause 4.3.
- 5.7 Tenderers are not restrained or barred from participating in public Procurement on grounds of execution of defective supply in the past under any Contract.
- 5.8 Tenderers are not under a declaration of ineligibility by an international financing agency such as World Bank, Asian Development Bank or any other international agency.
- 5.9 Tenderers shall not be insolvent, be in receivership, be bankrupt, be in the process of bankruptcy, be not temporarily barred from undertaking business

and it shall not be the subject of legal proceedings for any of the foregoing.

5.10 Tenderers shall have fulfilled its obligations to pay taxes and social security contributions under the provisions of laws and regulations of the country of its origin. In the case of foreign Tenderers, a certificate of competent authority in that country of which the Tenderer is citizen shall be provided.

5.11 Tenderers shall provide such evidence of their continued eligibility satisfactory to the Purchaser, as the Purchaser will reasonably request.

5.12 These requirements for eligibility will extend, as applicable, to Sub-contractor proposed by the Tenderer.

6. Eligible Goods and Related Services

6.1 All goods and related services to be supplied under the contract are eligible, unless their origin is from a country specified in the TDS.

6.2 For purposes of this Clause, the term “goods” includes commodities, raw material, machinery, equipment, and industrial plants; and “related services” includes services such as insurance, transportation, installation, and commissioning, training, and initial maintenance.

6.3 For purposes of this clause, “origin” means the country where the goods have been mined, grown, cultivated, produced, manufactured or processed; or through manufacture, processing, or assembly, another commercially recognized article results that differs substantially in its basic characteristics from its components.

6.4 The origin of goods and services is distinct from the nationality of the Tenderer. The nationality of the firm that produces, assembles, distributes, or sells the goods shall not determine their origin.

7. Site Visit

7.1 For goods contracts requiring installation/ commissioning/ networking or similar services at site, the Tenderer, at the Tenderer’s own responsibility and risk, is encouraged to visit and examine the Site and obtain all information that may be necessary for preparing the Tender and entering into a contract for the supply of goods and related services.

7.2 The Tenderer should ensure that the Purchaser is informed of the visit in adequate time to allow it to make appropriate arrangements.

7.3 The costs of visiting the Site shall be at the Tenderer’s own expense.

B. Tender Document

8. Tender Document: General

8.1 The Sections comprising the Tender Document are listed below and should be read in conjunction with any addendum issued under ITT Clause 11.

- Section 1 Instructions to Tenderers (ITT)
- Section 2 Tender Data Sheet (TDS)
- Section 3 General Conditions of Contract (GCC)
- Section 4 Particular Conditions of Contract (PCC)
- Section 5 Tender and Contract Forms
- Section 6 Schedule of Requirements

- Section 7 Technical Specifications
- Section 8 Drawings

8.2 The Purchaser shall reject any Tender if the Tender Document was not purchased directly from the Purchaser, or through its agent as stated in the TDS.

8.3 The Tenderer is expected to examine all instructions, forms, terms, and specifications in the Tender Document as well as addendum to Tender Documents.

9. Clarification of Tender Documents

9.1 A prospective Tenderer requiring any clarification of the Tender Document shall contact the Purchaser in writing at the Purchaser's address indicated in the TDS before **two-third** of time allowed for preparation and submission of Tender elapses.

9.2 A Purchaser is not obliged to answer any clarification received after that date requested under ITT Sub-Clause 9.1.

9.3 The Purchaser shall respond in writing within five (5) working days of receipt of any such request for clarification received under ITT Sub-Clause 9.1

9.4 The Purchaser shall forward copies of its response to all those who have purchased the Tender Document, including a description of the enquiry but without identifying its source.

9.5 Should the Purchaser deem it necessary to amend the Tender Document as a result of a clarification, it shall do so following the procedure under ITT Clause 11.

10. Pre-Tender Meeting

10.1 To clarify issues and to answer questions on any matter arising in the Tender Document, the Purchaser may, if stated in the TDS, hold a Pre-Tender Meeting at the place, date and time as specified in the TDS. All Potential Tenderers are encouraged to attend the meeting, if it is held.

10.2 Minutes of the pre-Tender meeting, including the text of the questions raised and the responses given, together with any responses prepared after the meeting, will be transmitted within one week (7 days) after holding the meeting to all those who purchased the Tender Document and even those who did not attend the meeting.

10.3 Any amendment to the Tender Document listed in ITT Sub-Clause 8.1 that may become necessary as a result of the pre-Tender meeting shall be made by the Purchaser exclusively through the issue of an Addendum as stated under ITT Sub-Clause 11 and not through the minutes of the pre-Tender meeting.

10.4 Non-attendance at the pre-Tender meeting will not be a cause for disqualification of a Tenderer.

11. Addendum to Tender Documents

11.1 At any time prior to the deadline for submission of Tenders, the Purchaser on its own initiative or in response to a clarification request in writing from a Tenderer, having purchased the Tender Document or as a result of a Pre-Tender meeting, may revise the Tender Document by issuing an addendum pursuant to Rule 95 of the Public Procurement Rules, 2008.

- 11.2 The addendum issued under ITT Sub-Clause 11.1 shall become an integral part of the Tender Document and shall have a date and an issue number and shall be circulated by fax, mail or e-mail, to Tenderers who have purchased the Tender Documents within five (5) working days of issuance of such addendum, to enable Tenderers to take appropriate action.
- 11.3 The Tenderer shall acknowledge receipt of an addendum.
- 11.4 Tenderers who have purchased the Tender Documents but have not received any addendum issued under ITT Sub-clause 11.1 shall inform the Purchaser of the fact by fax, mail or e-mail before **two-third** of the time allowed for the submission of Tenders has elapsed.
- 11.5 Procuring Entities shall also ensure posting of relevant addenda with the reference number and date on their website.
- 11.6 To give a prospective Tenderer reasonable time in which to take an amendment into account in preparing its Tender, the Purchaser may, at its discretion, extend the deadline for the submission of Tenders, pursuant to Rule 95(6) of the Public Procurement Rule, 2008 and under ITT Clause 36.
- 11.7 If an addendum is issued when time remaining is less than one-third of the time allowed for the preparation of Tenders, a Purchaser shall extend the deadline by an appropriate number of days for the submission of Tenders, depending upon the nature of the Procurement requirement and the addendum. The minimum time for such extension shall not be less than seven (7) days.

C. Qualification Criteria

- 12. General Criteria**
- 12.1 The Purchaser requires the Tenderer to be qualified by meeting predefined, precise minimum requirements, which entails setting pass/fail criteria, which if not met by the Tenderer, will result in rejection of its Tender.
- 12.2 In addition to meeting the eligibility criteria, as stated in ITT Clause 5, the Tenderer must satisfy the other criteria stated in ITT Clauses 13 to 15 inclusive.
- 12.3 To qualify for a multiple number of lots in a package for which tenders are invited in the Invitation for Tenders, The Tenderer shall demonstrate having resources and experience sufficient to meet the aggregate of the qualifying criteria for the individual lot. The requirement of overall experience and specific experience under ITT Sub-Clause 14.1 (a) and 14.1 (b) shall not be separately applicable for individual lot.
- 13. Litigation History**
- 13.1 The maximum number of arbitration awards against the Tenderer over a period shall be as specified in the TDS.
- 14. Experience Criteria**
- 14.1 Tenderers shall have the following minimum level of supply experience to qualify for supplying the Goods and Related Services under the contract:
- (a) A minimum number of years of overall experience in the supply of goods and related services as specified in the TDS; and

- (b) Specific experience of satisfactory completion of supply of similar goods of minimum value stated in the TDS under maximum number of contracts stated in TDS within the period stated in TDS; and
- (c) A minimum supply and/or production capacity of Goods as specified in the TDS.

15. Financial Criteria

- 15.1 Tenderers shall have the following minimum level of financial capacity of qualify for the supply of goods under the contract:
- (a) Availability of minimum liquid assets or working capital or credit facilities from a Bank, as specified in the TDS.

16. Appointment of Subcontractor

- 16.1 Tenderer, pursuant to Rule 53 of the PPR2008, is allowed to sub-contract a portion of the Supply.
- 16.2 The Tenderer shall specify in its Tender all portion of the Goods that will be Subcontracted, if any, including the entity(ies) to whom each portion will be subcontracted to, subject to the maximum allowable limit for subcontracting of Goods specified in the TDS.
- 16.3 All subcontracting arrangement must be disclosed at the time of Tendering, and subcontractors must be identified in the Tender submitted by Tenderer.
- 16.4 A Subcontractor may participate in more than one Tender, but only in that capacity.
- 16.5 Subcontractors must comply with the provision of ITT Clause 5. For this purpose contractor shall complete the Subcontractor's information in FormPG4-1 for submission with tender.
- 16.6 If the Purchaser determines that a subcontractor is ineligible, the subcontracting of such portion of the Goods assigned to the ineligible subcontractor shall be disallowed.

D. Tender Preparation

17. Only One Tender

- 17.1 If a Tender for Goods is invited on 'lot-by-lot' basis, each lot shall constitute a Tender. A Tenderer shall submit only one (1) Tender for each lot, A Tenderer who submits or participates in more than one (1) Tender for each lot will cause all the Tenders with that Tenderer's participation to be rejected.

18. Cost of Tendering

- 18.1 Tenderers shall bear all costs associated with the preparation and submission of its Tender, and the Purchaser shall not be responsible or liable for those costs, regardless of the conduct or outcome of the Tendering process.

19. Issuance and Sale of Tender Document

- 19.1 A Purchaser, pursuant to Rule 94 of the Public Procurement Rules, 2008 shall make Tender Documents available immediately to the potential Tenderers, requesting and willing to purchase at the corresponding price if the advertisement has been published in the newspaper pursuant to Rule 90 of the Public Procurement Rules, 2008.
- 19.2 Full contact details with mailing address, telephone and facsimile numbers and electronic mail address, as applicable, of those to whom Tender Documents have been issued shall be recorded with a reference number by

the Purchaser or its agent.

19.3 There shall not be any pre-conditions whatsoever, for sale of Tender Document and the sale of such Document shall be permitted up to the day prior to the day of deadline for the submission of Tender.

20. Language of Tender

20.1 Tenders shall be written in English language. Supporting documents and printed literature furnished by the Tenderer may be in another language provided they are accompanied by an accurate translation of the relevant passages into the English language, in which case, for purposes of interpretation of the Tender, such translation shall govern.

20.2 Tenderers shall bear all costs of translation to the governing language and all risks of the accuracy of such translation.

21. Contents of Tender

21.1 The Tender prepared by the Tenderer shall comprise the following:

- (a) Tender Submission Letter (Form PG4-1) as furnished in Section 5: Tender and Contract Forms;
- (b) Tenderer information sheet (Form PG4-2) as furnished in Section 5: Tender and Contract Forms;
- (c) The completed Price Schedule for Goods and Related Services (Form PG4-3A, 3B, 3C and PG4-3D) as furnished in Section 5: Tender and Contract Forms as stated under ITT Clauses 23 and 24;
- (d) Tender Security as stated under ITT Clause 29,30 and 31;
- (e) The completed Specifications Submission and Compliance Sheet (Form PG4-4) as furnished in Section 5: Tender and Contract Forms as stated under ITT clause 25.2;
- (f) Alternatives, if permitted, as stated under with ITT Clause 22;
- (g) Written confirmation authorising the signatory of the Tender to commit the Tenderer, as stated under ITT Sub-Clause 34.3;
- (h) The completed eligibility declarations, to establish its eligibility as stated under ITT Clause 5, in the Tender Submission Sheet (Form PG4-1), as furnished in section 5: Tender and Contract Forms;
- (i) An affidavit confirming the legal capacity stating that there are no existing orders of any judicial court that prevents either the Tenderer or employees of a Tenderer entering into or signing a Contract with the Purchaser as stated under ITT clause 5;
- (j) An affidavit confirming that the Tenderer is not insolvent, in receivership or not bankrupt or not in the process of bankruptcy, not temporarily barred from undertaking their business for financial reasons and shall not be the subject of legal proceedings for any of the foregoing as stated under ITT Clause 5;
- (k) A certificate issued by the competent authority stating that the Tenderer is a Tax payer having valid Tax identification Number (TIN) and VAT registration number or in lieu any other document acceptable to the Purchaser demonstrating that the Tenderer is a genuine Tax payer and has a VAT registration number as a proof of fulfillment of taxation obligations as stated under ITT Clause 5. In the case of foreign Tenderers, a certificate of competent authority in that country

of which the Tenderer is citizen shall be provided ;

- (l) Documentary evidence demonstrating that they are enrolled in the relevant professional or trade organizations registered in Bangladesh or in case of foreign tenderer in their country of origin or a certificate concerning their competency issued by a professional institution in accordance with the law of the country of their origin, as stated under ITT Clause 5;
- (m) The country of origin declarations, to establish the eligibility of the Goods and Related Services as stated under ITT Clause 6, in the Price Schedule for Goods and Related Services (Form PG4-3B, 3C and PG4-3D) as, applicable, furnished in Section 5: Tender and Contract Forms;
- (n) Documentary evidence as stated under ITT Clauses 25, that the Goods and Related Services conform to the Tender Documents;
- (o) Documentary evidence as stated under ITT Clause 26 that the Tenderer's qualifications conform to the Tender Documents;
- (p) Documents establishing legal and financial autonomy and compliance with commercial law, as stated under ITT Sub-clause 5.3 in case of government owned entity; and
- (q) Any other document as specified in the TDS.

21.2 The Tenderer shall submit the Tender Submission Letter (Form PG4-1) as furnished in Section 5: Tender and Contract Forms. This form must be completed without any alterations to its format, and no substitutes shall be accepted. All blank spaces shall be filled in with the information requested.

21.3 The Tenderer shall submit the completed Price Schedule for Goods and Related Services (Form PG4-3A, 3B, 3C and PG4-3D), according to their origin as appropriate as furnished in section 5: Tender and Contract Forms.

22. Alternatives

22.1 Unless otherwise stated in the TDS, alternatives shall not be considered.

23. Tender Prices, Discounts

23.1 The prices and discounts quoted by the Tenderer in the Tender Submission Letter (Form PG4-1) and in the Price Schedule (Form PG4-3A, 3B, 3C and PG4-3D) shall conform to the requirements specified below.

23.2 All lots or items as listed in Section 6: Schedule of Requirements must be listed and priced separately on the Price Schedule following the Form PG4-3A, 3B, 3C and PG4-3D as applicable.

23.3 Tenders are being invited either for a single lot or for a number of lots on 'lot-by-lot' basis, as specified in the TDS.

23.4 Each lot shall constitute a Tender, If Tenders for Goods are invited on 'lot-by-lot' basis.

23.5 Tenders being invited for a single lot or for a number of lots on 'lot-by-lot' basis, price quoted shall correspond to 100% of the items specified for each lot and to 100% of the quantities specified for each item of that particular lot and shall correspond to 100% of the total offered lot value, unless otherwise stated in the TDS

- 23.6 A Lot Tender not offering minimum number of items of those being priced based on percentage of the total number of items, and, the corresponding minimum value based on percentage of the total lot value, as specified in the ITT Sub-Clause 23.5 shall also be considered non-responsive.
- 23.7 Subject to ITT Sub-Clause 23.5, a Lot tender not offering a particular item which represents more than fifty percent (50%) of the estimated lot value identified by the Purchaser and specified in the TDS, even if it complies with the requirement of minimum number of items based on percentage of the total number of items as stated under ITT Sub Clause 23.5, shall be considered non-responsive.
- 23.8 The price to be quoted in Tender Submission Letter (Form PG4-1) shall be the total price of the Tender, excluding any discounts offered, only **in case of being awarded more than one lot**, by the Tenderer
- 23.9 The Tenderer wishing to offer any discount shall indicate the methodology for their application in the Tender Submission Letter (Form PG4-1) **for being awarded of more than one lot**.
- 23.10 Prices shall be quoted as specified in each Price Schedule (Form PG4-3A, 3B, 3C and PG4-3D) as applicable. The disaggregation of price components is required solely for the purpose of facilitating the comparison of tenders by the Purchaser. This shall not in any way limit the Purchaser's right to contract on any of the terms offered. In quoting prices, the Tenderer shall be free to use transportation through carriers registered in any eligible Countries. Similarly, the Tenderer may obtain insurance services from any eligible country. Prices shall be entered in the following manner:
- 23.11 For Goods, manufactured within Bangladesh, the prices in the Price schedule (Form PG4-3A) shall be entered separately in the following manner:
- (a) the price of the Goods quoted EXW (ex works, ex factory, ex warehouse, ex showroom, or off-the-shelf, as applicable), including all customs duties and import vat and other taxes already paid or payable on the components and raw material used in the manufacture or assembly of the Goods;
 - (b) VAT payable on account of supplier, if the contract is awarded ; and
 - (c) the price for inland transportation, insurance, and other local costs for the delivery of the Goods to their final destination (Project Site) specified in the TDS.

23.12 For Goods, manufactured outside Bangladesh, to be imported, the prices in the Price schedule (Form PG4-3B) shall be entered separately in the following manner:

- (a) the price of the Goods, quoted CIP (named place of destination, in the Bangladesh) or CIF (named port of destination, in Bangladesh) as specified in the TDS;
- (b) VAT payable on account of supplier, if the contract is awarded; and
- (c) the price for inland transportation, insurance, and other local costs for the delivery of the Goods to their final destination (Project Site) specified in the TDS;
- (d) in addition to the CIP/CIF prices specified in 23.12(a) above, the price of the Goods to be imported may be quoted in other *INCOTERM* and shall be governed by the rules prescribed in the current edition of *INCOTERM* published by the International Chamber of Commerce, Paris, if so specified in the TDS;

23.13 For Goods, manufactured outside Bangladesh, already imported, the prices in the Price schedule (Form PG4-3C) shall be entered separately in the following manner:

- (a) the price of the Goods, including the original import value of the Goods; plus any mark-up ; plus any other related local cost, and custom duties, import VAT and other import taxes already paid on the Goods already imported.
- (b) the custom duties, import VAT and other import taxes already paid (need to be supported with documentary evidence) on the Goods already imported;
- (c) the price of the Goods, obtained as the difference between (a) and (b) above;
- (d) VAT payable on account of supplier, if the contract is awarded; and
- (e) the price for inland transportation, insurance, and other local costs for the delivery of the Goods to their final destination (Project Site) specified in the TDS.

[For previously imported Goods, the quoted price shall be distinguishable from the original import value of these Goods declared to customs and shall include any rebate or mark-up of the local agent or representative and all local costs except import duties and taxes, which have been paid. For clarity the tenderers are asked to quote the price including import duties, and additionally to provide the import duties and the price net of import duties which is the difference of those values.]

23.14 for Related Services, other than inland transportation and other services required to convey the Goods to their final destination, whenever such Related Services are specified in the Schedule of Requirements, the prices in the price schedule (Form PG4-3D) shall be entered in the following manner :

- (a) the price of each item comprising the Related Services (inclusive of any applicable taxes).

- 24. Tender Currency**
- 24.1 For expenditures that will be incurred in Bangladesh, the Tenderer shall quote the prices in Bangladesh Taka.
- 24.2 Suppliers offering Goods manufactured or assembled in Bangladesh, are permitted to submit their Tender in a combination of local and foreign currencies.
- 24.3 For expenditures that will be incurred outside Bangladesh, the Tenderer may quote the prices in USD or GBP or EUR or JPY as specified in TDS.
- 25. Documents
Establishing the
Conformity of the
Goods and
Related services**
- 25.1 To establish the conformity of the Goods and Related Services to the Tender Documents, the Tenderer shall furnish as part of its Tender the documentary evidence that the Goods and Related services conform to the technical specifications and standards in Section 7, Technical Specifications.
- 25.2 Documentary evidence of conformity of the Goods and services to the Tender Documents may be in the form of literature, drawings, and data, and shall consist of:
- (a) a detailed description of the essential technical and performance characteristics of the Goods;
 - (b) if so required in TDS, tenderer shall also furnish a list giving full particulars, including available sources and current prices of spare parts, special tools, etc., necessary for the proper and continuing functioning of the Goods during the period specified in the TDS, following commencement of the use of the Goods by the Purchaser ; and
 - (c) an item-by-item commentary on the Purchaser's Technical Specifications demonstrating substantial responsiveness of the Goods and Related services to those specifications, or a statement of deviations and exceptions to the provisions of Section 7. Technical Specifications.
- 26. Documents
Establishing
Qualifications of
the Tenderer**
- 26.1 The documentary evidence of the Tenderer's qualifications to perform the contract if its Tender is accepted shall establish to the Purchaser's satisfaction:
- (a) that the Tenderer meets each of the qualification criterion specified in Sub-Section C, Qualification Criteria of the ITT;
 - (b) that, if required in the TDS, a Tenderer that does not manufacture or produce the Goods it offers to supply shall submit the Manufacturer's Authorization Letter (Form PG4-5) furnished in Section 5: Tender and Contract Forms, to demonstrate that it has been duly authorized by the manufacturer or producer of the Goods to supply the Goods to Bangladesh.; and
 - (c) that, if required in the TDS, in case of a Tenderer not doing business within Bangladesh, the Tenderer is or will be (if awarded the contract) represented by an Agent in the country equipped and able to carry out the Supplier's maintenance.
- 27. Validity Period of
Tender**
- 27.1 Tender validities shall be determined on the basis of the complexity of the Tender and the time needed for its examination, evaluation, approval of the Tender and issuance of the Notification of Award pursuant to Rule 19 and 20 of the Public Procurement Rules,2008.
- 27.2 Tenders shall remain valid for the period specified in the TDS after the date of

Tender submission deadline prescribed by the Purchaser, as stated under ITT Clause 36. A Tender valid for a period shorter than that specified will be rejected by the Purchaser as non-responsive.

28. Extension of Tender Validity and Tender Security

- 28.1 In justified exceptional circumstances, prior to the expiration of the Tender validity period, the Purchaser following Rule 21 of the Public Procurement Rules, 2008 may solicit, **not later than ten (10) days** before the expiry date of the Tender validity, compulsorily all the Tenderers' consent to an extension of the period of validity of their Tenders.
- 28.2 The request for extension of Tender validity period shall state the new date of the validity of the Tender.
- 28.3 The request from the Purchaser and the responses from the Tenderers will be made in writing.
- 28.4 Tenderers consenting in writing to the request made by the Purchaser under ITT Sub-Clause 28.1 shall also correspondingly extend the validity of its Tender Security for twenty-eight (28) days beyond the new date for the expiry of Tender validity.
- 28.5 Tenderers consenting in writing to the request under ITT Sub-Clause 28.1 shall not be required or permitted to modify its Tender in any circumstances.
- 28.6 If the Tenderers are not consenting in writing to the request made by the Purchaser under ITT Sub-Clause 28.1, its Tender will not be considered for subsequent evaluation.

29. Tender Security

- 29.1 The Tender Security and its amount shall be determined sufficient to discourage the submission of frivolous and irresponsible tenders pursuant to Rule 22 of the Public Procurement Rule, 2008 and shall be expressed as a rounded fixed amount and, shall not be stated as a precise percentage of the estimated total Contract value.
- 29.2 The Tenderer shall furnish as part of its Tender, in favour of the Purchaser or as otherwise directed on account of the Tenderer as specified in TDS.
- 29.3 Amount of the Tender security may be determined on the basis of different percentages for each lot, but the amount in fixed and currency as specified in TDS, if so indicated that the Tenders are invited on lot-by-lot basis under ITT Sub Clause 23.3

30. Form of Tender security

- 30.1 The Tender Security shall be in the form of an irrevocable bank guarantee issued by an internationally reputable bank and shall require to be endorsed by its any correspondent bank located in Bangladesh, to make it enforceable, in the format (Form PG4-6) furnished in Section 5: Tender and Contract Forms;
- 30.2 be payable promptly upon written demand by the Purchaser in the case of the conditions listed in ITT Clause 33 being invoked; and
- 30.3 remain valid for at least twenty eight (28) days beyond the expiry date of the Tender Validity in order to make a claim in due course against a Tenderer in the circumstances detailed under ITT Clause 33 and pursuant to Rule 25 of the Public Procurement Rules, 2008.

- 31. Authenticity of Tender Security**
- 31.1 The authenticity of the Tender security submitted by a Tenderer shall be examined and verified by the Purchaser in writing from the Bank issuing the security, prior to finalization of the Evaluation Report pursuant to Rule 24 of the Public Procurement Rule, 2008.
- 31.2 If a Tender Security is found to be not authentic, the Tender which it covers shall not be considered for subsequent evaluation and in such case the Purchaser shall proceed to take punitive measures against that Tenderer as stated under ITT Sub-Clause 4.6, pursuant to Rule 127 of the Public Procurement Rules, 2008 and in accordance with Section 64(5) of the Public Procurement Act, 2006.
- 31.3 Tender not accompanied by a valid Tender Security as stated under Sub-Clause 29, 30 and 31, shall be considered as non-responsive.
- 32. Return of Tender Security**
- 32.1 No Tender security shall be returned by the Tender Opening Committee (TOC) during and after the opening of the Tenders pursuant to Rule 26 of the Public Procurement Rules 2008.
- 32.2 No Tender security shall be returned to the Tenderers before contract signing, except to those who are found non-responsive.
- 32.3 Tender securities of the non-responsive Tenders shall be returned immediately after the Evaluation Report has been approved by the Purchaser.
- 32.4 Tender securities of the responsive Tenderers shall be returned only after the lowest evaluated responsive Tenderer has submitted the performance security and signed the contract, that being even before the expiration of the validity period specified in Clause 27.
- 32.5 Tender Securities of the Tenderers not consenting within the specified date in writing to the request made by the Purchaser under ITT Sub-Clause 28.1 in regard to extension of its Tender validity shall be discharged or returned forthwith.
- 33. Forfeiture of Tender Security**
- 33.1 The Tender security pursuant to Rule 25 of the Public Procurement Rules, 2008 may be forfeited if a Tenderer:
- (a) withdraws its Tender after opening of Tenders but within the validity of the Tender as stated under ITT Clauses 27, and 28, pursuant to Rule 19 of the Public Procurement Rules 2008; or
 - (b) refuses to accept a Notification of Award as stated under ITT Sub-Clause 62.3, pursuant to Rule 102 of the Public Procurement Rules 2008; or
 - (c) fails to furnish performance security as stated under ITT Sub-Clause 63.2, pursuant to Rule 102 of the Public Procurement Rules 2008; or
 - (d) refuses to sign the Contract as stated under ITT Sub-Clause 67.2 pursuant to Rule 102 of the Public Procurement Rules 2008; or
 - (e) does not accept the correction of the Tender price following the correction of arithmetic errors as stated under ITT Clause 49, pursuant to Rule 98(11) of the Public Procurement Rules 2008
- 34. Format and Signing of Tender**
- 34.1 The Tenderer shall prepare one (1) original of the documents comprising the Tender as described in ITT Clause 21 and clearly mark it "ORIGINAL". In addition, the Tenderer shall prepare the number of copies of the Tender, as specified in the TDS and clearly mark each of them "COPY". In the event of any discrepancy between the

original and the copies, the original shall prevail.

- 34.2 Alternatives, if permitted under ITT Clause 22, shall be clearly marked “Alternative”.
- 34.3 The original and each copy of the Tender shall be typed or written in indelible ink and shall be signed by a person duly authorised to sign on behalf of the Tenderer. This authorisation shall consist of a written authorisation and shall be attached to the Tender Submission Letter (Form PG4-1).
- 34.4 The name and position held by each person signing the authorisation must be typed or printed below the signature.
- 34.5 All pages of the original and of each copy of the Tender, except for un-amended printed literature, shall be numbered sequentially and signed or initialled by the person signing the Tender.
- 34.6 Any interlineations, erasures, or overwriting shall be valid only if they are signed or initialled by the person(s) signing the Tender.
- 34.7 Person(s) signing the Tender shall describe his or her name, address, position.

E. Tender Submission

35. Sealing, Marking and Submission of Tender

- 35.1 The Tenderer shall enclose the original in one (1) envelope and all the copies of the Tender, including the alternative, if permitted under ITT Clause 22 in another envelope, duly marking the envelopes as “ORIGINAL” “ALTERNATIVE” (if permitted) and “COPY.” These sealed envelopes will then be enclosed and sealed in one (1) single outer envelope.
- 35.2 Tenders shall be properly marked by Tenderers in order not be confused with other types of correspondence which may also be hand-delivered or posted by mail or courier service. The inner and outer envelopes shall:
- (a) bear the name and address of the Tenderer ;
 - (b) be addressed to the Purchaser as stated under ITT Sub-Clause 36.1;
 - (c) bear the specific identification of this tendering process indicated in ITT Sub-Clause 1.2 and any additional identification marks as specified in the TDS; and
 - (d) bear a statement “DO NOT OPEN BEFORE...” the time and date for Tender opening, as stated under ITT Sub- Clause 42.2
- 35.3 The Tenderer is solely and entirely responsible for pre-disclosure of Tender information if the envelope(s) are not properly sealed and marked.
- 35.4 Tenders shall be delivered by hand or by mail, including courier services to location as designated in the ITT Sub-Clause 36.1.
- 35.5 Tenders shall be submitted on the basis of this Tender Document issued by the Purchaser.
- 35.6 The Purchaser will, on request, provide the Tenderer with a receipt showing the date and time when it’s Tender was received.
- 35.7 When so specified in the TDS, tenderers shall have the option of submitting their

tenders electronically.

35.8 Tenderers submitting tenders electronically shall follow the electronic tender submission procedures specified in the TDS.

36. Deadline for Submission of tenders

36.1 Tenders shall be delivered to the Purchaser at the address specified in the TDS and no later than the date and time specified in the TDS.

36.2 The Purchaser may, at its discretion on justifiably acceptable grounds duly recorded, extend the deadline for submission of Tender as stated under ITT Sub Clause 36.1, in which case all rights and obligations of the Purchaser and Tenderers previously subject to the deadline will thereafter be subject to the new deadline as extended.

37. Late tender

37.1 Any Tender received by the Purchaser after the deadline for submission of Tenders as stated under ITT Sub-Clause 36.1, shall be declared LATE, rejected, returned unopened to the Tenderer.

38. Modification, Substitution or Withdrawal of Tenders

38.1 A Tenderer may modify, substitute or withdraw its Tender after it has been submitted by sending a written notice duly signed by the authorised signatory properly sealed, and shall include a copy of the authorisation (the power of attorney), confirmed by an affidavit duly authenticated as stated under ITT Clause 34.3, provided that such written notice including the affidavit is received by the Purchaser prior to the deadline for submission of Tenders as stated under ITT Sub-Clause 36.1.

39. Tender Modification

39.1 The Tenderer shall not be allowed to retrieve its original Tender, but shall be allowed to submit corresponding modification to its original Tender marked as "MODIFICATION".

40. Tender Substitution

40.1 The Tenderer shall not be allowed to retrieve its original Tender, but shall be allowed to submit another Tender marked as "SUBSTITUTION".

41. Withdrawal of Tender

41.1 The Tenderer shall be allowed to withdraw its Tender by a Letter of Withdrawal marked as "WITHDRAWAL".

F. Tender Opening and Evaluation

42. Tender Opening

42.1 Tenders shall be opened pursuant to Rule 97 following steps in Part D of Schedule IV of The Public Procurement Rule, 2008.

42.2 Tenders shall be opened in public immediately after the deadline for submission of Tenders at the place, date and time as specified in the TDS but no later than **ONE HOUR** after expiry of the submission deadline. Tender opening shall not be delayed on the plea of absence of Tenderers or his or her representatives.

42.3 Any specific electronic Tender opening procedures required if electronic tendering is permitted under ITT Sub-Clause 35.7, shall be as specified in the TDS.

42.4 Persons not associated with the Tender may not be allowed to attend the public opening of Tenders.

42.5 The Tenderers' representatives shall be duly authorized by the Tenderer. Tenderers or their authorised representatives will be allowed to attend and witness the opening of Tenders, and will sign a register evidencing their attendance.

42.6 The authenticity of withdrawal or substitution of, or modifications to original Tender,

if any made by a Tenderer in specified manner, shall be examined and verified by the Tender Opening Committee based on documents submitted under ITT Sub Clause 38.1.

42.7 Tenders will be opened in the following manner:

- (a) firstly, envelopes marked “Withdrawal” shall be opened and “Withdrawal” notices read aloud and recorded, and the envelope with the corresponding Tender shall not be opened, but returned unopened to the Tenderer by the Purchaser at a later time immediately after preliminary examination by the Tender Evaluation Committee (TEC) as stated under ITT Sub-Clause 45.1. No Tender withdrawal shall be permitted unless the corresponding withdrawal notice contains a valid authorization to request the withdrawal and in such case the Tender shall be read aloud at the Tender opening ;
- (b) secondly, the remaining Tenders will be sorted out and those marked “substitutes” or “modified” will be linked with their corresponding “original”(O) Tender;
- (c) Next, envelopes marked “Substitution”(S) shall be opened and read aloud and recorded, and exchanged with the corresponding Tender being substituted, and the substituted Tender shall not be opened, but returned unopened to the Tenderer by the Purchaser at a later time immediately after preliminary examination by the Tender Evaluation Committee (TEC) as stated under ITT Sub-Clause 45.1 . No Tender substitution shall be permitted unless the corresponding substitution notice contains a valid authorization to request the substitution and in such case the Tender shall be read aloud at the Tender opening.
- (d) Next envelopes marked “Modification” (M) shall be opened and read aloud with the corresponding Tender and recorded. No Tender modification shall be permitted unless the corresponding modification notice contains a valid authorization to request the modification and in such case the Tender shall be read aloud at the Tender opening.
- (e) thirdly, if so specified in this Tender Document, the envelopes marked “ Alternative ”(A) shall be opened and read aloud with the corresponding Tender and recorded.

42.8 Ensuring that only the correct (M), (S), (A),(O) envelopes are opened, details of each Tender will be dealt with as follows:

- (a) the Chairperson of the Tender Opening Committee will read aloud each Tender and record in the Tender Opening Sheet (TOS)
 - (i) the name and address of the Tenderer;
 - (ii) state if it is a withdrawn, modified, substituted , or original tender;
 - (iii) the Tender price;
 - (iv) the number of initialled corrections;
 - (v) any discounts;
 - (vi) any alternatives;
 - (vii) the presence or absence of any requisite Tender Security; and
 - (viii) such other details as the Purchaser, at its discretion, may consider appropriate.
- (b) only discounts and alternative read aloud at the Tender opening will be considered in evaluation;
- (c) all pages of the original version of the Tender, except for un-amended

printed literature, will be initialled by members of the Tender Opening Committee.

42.9 Upon completion of Tender opening, all members of the Tender Opening Committee and the Tenderers or Tenderer's duly authorised representatives attending the Tender opening shall sign by name, address, designation and their national Identification Numbers the Tender Opening Sheet, copies of which shall be issued to the Head of the Purchaser or an officer authorised by him or her and also to the members of the Tender Opening Committee and any authorised Consultants and, to the Tenderers immediately.

42.10 The omission of a Tenderer's signature on the record shall not invalidate the contents and effect of the record under ITT Sub-Clause 42.8.

42.11 No Tender will be rejected at the Tender opening stage except the LATE Tenders. .

42.12 A copy of the record shall be distributed to all Tenderers who submitted tenders in time, and posted online when electronic tendering is permitted.

43. Evaluation of Tenders

43.1 Purchaser's Tender Evaluation Committee (TEC) shall examine, evaluate and compare Tenders that are responsive to the mandatory requirements of Tender Documents in order to identify the successful Tenderer.

43.2 Tenders shall be examined and evaluated only on the basis of the criteria specified in the Tender Document.

44. Evaluation process

44.1 The TEC may consider a Tender as responsive in the Evaluation, only if it is submitted in compliance with the mandatory requirements set out in the Tender Document. The evaluation process should begin immediately after tender opening following four steps:

- (a) Preliminary Examination;
- (b) Technical Examinations and Responsiveness;
- (c) Financial evaluation and price comparison;
- (d) Post-qualification of the lowest evaluated responsive Tenders.

45. Preliminary Examination

45.1 Compliance, adequacy and authenticity of the documentary evidences for meeting the qualification criterion specified in the corresponding section of the Tender document shall have to be preliminarily examined and verified.

45.2 The TEC shall firstly examine the Tenders to confirm that all documentation requested in ITT Clause 21 has been provided. Examination of the compliance, adequacy and authenticity of the documentary evidence may follow the order below:

- (a) verification of the completeness of the eligibility declaration in the Tender Submission Letter (Form PG4-1), to determine the eligibility of the tenderer as stated under ITT Sub-Clause 21(h). Any alterations to its format, filling in all blank spaces with the information requested, failing which the tender may lead to rejection of the Tender;
- (b) verification of that the Tenderer is enrolled in the relevant professional or trade organisations as stated under ITT Clause 21(1);
- (c) verification of the eligibility in terms of legal capacity and fulfilment of taxation obligation by the tenderer in accordance as stated under ITT Sub-Clause 21(i) and 21(k);

- (d) verification of eligibility that the tenderer is not insolvent, in receivership, bankrupt, not in the process of bankruptcy, not temporarily barred as stated under ITT Sub-Clause 21(j);
 - (e) verification of eligibility of Tenderer's country of origin as stated under ITT Sub-Clause 21(b);
 - (f) verification of the written authorization confirming the signatory of the Tenderer to commit the Tender has been attached with Tender Submission Letter (Form PG4-1) as stated under ITT Sub-Clause 21(g); in order to check the authenticity of Tender and Tenderer itself ;
 - (g) verification of the Tender Security as stated under ITT Sub-Clause 21(d); and
 - (h) Verification of that the written notice for 'WITHDRAWL' and 'SUBSTITUTION of' or MODIFICATION to, the corresponding Tender is proper and authentic, if the tender is "WITHDRAWN", "SUBSTITUTION" or "MODIFICATION", as stated under ITT Sub-Clause 38.1
- 45.3 The TEC shall confirm that the above documents and information have been provided in the Tender and the completeness of the documents and compliance of instructions given in corresponding ITT Clauses shall be verified, failing which the tender shall be considered as non-responsive.

46. Technical Examinations & Responsiveness

- 46.1 Only those Tenders surviving preliminary examination need to be examined in this phase.
- 46.2 Secondly, the TEC will examine the adequacy and authenticity of the documentary evidence which may follow the order below:
- (a) verification of the completeness of the country of origin declaration in the Price Schedule for Goods and Related Services (Form PG4-3B, 3C and PG4-3D) as furnished in Section 5: Tender and Contract Forms to determine the eligibility of the Goods and Related Services as stated under ITT Sub Clause 21(m).
 - (b) verification and examination of the documentary evidence and completed Specification Submission Sheet (Form PG4-4) as furnished in Section 5: Tender and Contract Forms to establish the conformity of the Goods and Related Services to the Tender Documents as stated under ITT Sub Clause 21(e) and 21(n).
 - (c) verification and examination of the documentary evidence that the Tenderer's qualifications conform to the Tender Documents and the Tenderer meets each of the qualification criterion specified in Sub-Section C, Qualification Criteria as stated under ITT Sub Clause 21(o).
 - (d) verification and examination of the documentary evidence that Tenderer has met all the requirements in regards to scope of Supply as stated under Section 6, Schedule of Requirements, without any material deviation or reservation.
- 46.3 TEC may consider a Tender as responsive in the evaluation, only if comply with the mandatory requirements as stated under Clause 46.2.
- 46.4 The TEC's determination of a Tender's responsiveness is to be based on the documentary evidence as requested in Clause 46.2 without recourse to extrinsic evidence.
- 46.5 Information contained in a Tender, that was not requested in the Tender Document

shall not be considered in evaluation of the Tender.

- 46.6 If a Tender is not responsive to the mandatory requirements set out in the Tender Document it shall be rejected by the TEC and shall not subsequently be made responsive by the Tenderer by correction of the material deviation, reservation.
- 46.7 A material deviation or reservation is one-
- (a) which affects in any substantial way the scope, quality, or performance of the Goods and Related Services and Tenderer's qualifications mentioned in the Tender Document.
 - (b) which limits in any substantial way, inconsistent with the Tender Documents, the Purchaser's rights or the Tenderer's obligations under the Contract; or
 - (c) whose rectification would anyway affect unfairly the competitive position of other Tenderers presenting responsive Tenders.
- 46.8 During the evaluation of Tender, the following definitions apply:
- (a) "Deviation" is a departure from the requirements specified in the Tender Document;
 - (b) "Reservation" is the setting of limiting conditions or withholding from complete acceptance of the requirements specified in the Tender Document;
- 46.9 A TEC may regard a Tender as responsive, even if it contains-
- (a) minor or insignificant deviations, which do not meaningfully alter or depart from the technical specifications, characteristics and commercial terms and conditions or other requirements set out in the Tender Document;
 - (b) errors or oversights, which if corrected, would not alter the key aspects of the Tender.

47. Clarification on Tender

- 47.1 The TEC may ask Tenderers for clarifications of their Tenders, including breakdowns of unit rates, in order to assist the examination and evaluation of the Tenders, provided that, Tender clarifications which may lead to a change in the substance of the Tender or in any of the key elements of the Tender as stated under ITT Sub-Clause 46.7, shall neither be sought nor permitted by the TEC.
- 47.2 Change in the tender price shall not be sought or permitted, except to confirm correction of arithmetical errors discovered by the Purchaser in the evaluation of the Tender, as sated under ITT Clause 49.
- 47.3 Any request for clarifications by the TEC shall not be directed towards making an apparently non-responsive Tender responsive and reciprocally the response from the concerned Tenderer shall not be articulated towards any addition, alteration or modification to its Tender.
- 47.4 If a Tenderer does not provide clarifications of its Tender by the date and time set in the TEC's written request for clarification, its Tender shall not be considered in the evaluation.
- 47.5 Requests for clarification shall be in writing and shall be signed only by the Chairperson of the TEC.

48. Restrictions on

- 48.1 Following the opening of Tenders until issuance of Notification of Award no

the Disclosure of Information Relating to the Procurement Process

Tenderer shall, unless requested to provide clarification to its Tender or unless necessary for submission of a complaint, communicate with the concerned Purchaser pursuant to Rule 31 of the Public Procurement Rule, 2008.

48.2 Tenderers shall not seek to influence in anyway, the examination and evaluation of the Tenders.

48.3 Any effort by a Tenderer to influence a Purchaser in its decision concerning the evaluation of Tenders, Contract awards may result in the rejection of its Tender as well as further action in accordance with Section 64 (5) of the Public Procurement Act 2006.

48.4 All clarification requests shall remind Tenderers of the need for confidentiality and that any breach of confidentiality on the part of the Tenderer may result in their Tender being disqualified.

48.5 Information relating to the examination, evaluation, comparison, and post qualification of the tender or contract award, shall not be disclosed to tenderers or any other persons not officially concerned with such process.

49. Correction of Arithmetical Errors

49.1 The TEC shall correct any arithmetic errors that are discovered during the examination of Tenders, and shall promptly notify the concerned Tenderer(s) of any such correction(s) pursuant to Rule 98(11) of the Public Procurement Rule, 2008.

49.2 Provided that the Tender is responsive, TEC shall correct arithmetical errors on the following basis:

(a) If there is a discrepancy between the unit price and the line item total that is obtained by multiplying the unit price by the quantity, the unit price shall prevail and the line item total shall be corrected, unless in the opinion of the TEC there is an obvious misplacement of the decimal point in the unit price, in which case the total price as quoted will govern and the unit price will be corrected;

(b) If there is an error in a total corresponding to the addition or subtraction of subtotals, the subtotals shall prevail and the total shall be corrected.

49.3 Any Tenderer that does not accept the correction of the Tender amount following correction of arithmetic errors as determined by the application of ITT Sub-Clause 49.2 shall be considered as non-responsive.

50. Conversion to Single Currency

50.1 For evaluation and comparison purpose, TEC shall convert all Tender prices expressed in the amounts in various currencies into an amount in Bangladeshi Taka currency, using the **selling exchange rates** established by the Bangladesh Bank, on the date of **Tender opening**.

51. Domestic Preference

51.1 **Domestic preference** shall be a factor in tender evaluation, unless otherwise specified in the TDS

51.2 If **domestic preference shall be a tender-evaluation factor**, the Purchaser will grant a margin of fifteen percent (15%) domestic preference to Goods manufactured in Bangladesh during the evaluation of its Tender while comparing the same with those of other Tenderers under the classification set out in ITT Sub-Clause 51.3. The evaluation will be carried out in accordance with the provisions set out in ITT Clause 54.

- 51.3 Tenders will be classified in one of two groups, as follows:
- (a) **Group A:** Tender offering goods manufactured in Bangladesh, for which:
 - (i) labour, raw materials, and components from within the Bangladesh account for more than thirty (30) percent of the EXW price; and
 - (ii) the production facility in which they will be manufactured or assembled has been engaged in manufacturing or assembling such goods at least since the date of tender submission.
 - (b) **Group B:** Tenders offering Goods manufactured outside Bangladesh that have been already imported or that will be imported.

51.4 To facilitate this classification by the Tenderer, the Tenderer shall complete whichever Form of the Price Schedule furnished in the Tender Document is appropriate.

51.5 Completion of an inappropriate Form of the Price Schedule by the Tenderer shall not result in rejection of its tender, but merely in the Purchaser's reclassification of the tenderer into its appropriate tender group.

52. Financial Evaluation

52.1 Thirdly the TEC, pursuant to Rule 98 of the Public Procurement Rules, 2008 shall evaluate each Tender that has been determined, up to this stage of the evaluation, to be responsive to the mandatory requirements in the Tender Document.

52.2 To evaluate a Tender in this stage, the Purchaser shall consider the following:

- (a) Verification and examination of the Price Schedule for Goods and Related Services (Form PG4-3A, 3B, 3C and PG4-3D) as furnished by the Tenderer and checking the compliance with the instructions provided under ITT Clause 23;
- (b) Evaluation will be done for Items or lot by lot as stated under ITT Clause 23 and the Total Tender Price as quoted in accordance with Clause 23 ;
- (c) Adjustment for correction of arithmetical errors as stated under ITT Sub-Clause 49.2;
- (d) Adjustment for price modification offered as stated under ITT Clause 38;
- (e) Adjustment due to discount as stated under ITT Sub-Clauses 23.8, 23.9 and 52.3;
- (f) Adjustment due to the application of economic factors of evaluation as stated under ITT Sub-Clause 52.5 if any;
- (g) Adjustment due to the assessment of the price of unpriced items as stated under ITT Clause 53 if any;
- (h) Adjustment due to the application of a margin of preference (domestic preference), in accordance with ITT Clause 54 if applicable

52.3 If Tenders are invited for a single lot or for a number of lots as stated under ITT Sub-clauses 23.3, TEC shall evaluate only lots that that have included at least the percentage of items per lot as stated under ITT Sub-Clause 23.5 and 23.6. The TEC shall evaluate and compare the Tenders taking into account:

- (a) Lowest evaluated tender for each lot;

- (b) The price discount/reduction per lot;
- (c) Least cost combination for the Purchaser, considering discounts and the methodology for its application as stated under ITT Sub-clauses 23.8 and 23.9 offered by the Tenderer in its Tender.

52.4 Only those spare parts and tools which are specified as a item in the List of Goods and Related Services in Section 6, Schedule of Requirement or adjustment as stated under ITT Sub-clause 52.5, shall be taken into account in the Tender evaluation. Supplier-recommended spare parts for a specified operating requirement as stated under ITT Sub-clause 25.2(b) shall not be considered in Tender evaluation.

52.5 The Purchaser's evaluation of a tender may require the consideration of other factors, in addition to the Tender Price quoted as stated under ITT Clause 23. The effect of the factors selected, if any, shall be expressed in monetary terms to facilitate comparison of tenders. The factors, methodologies and criteria to be used shall be as specified in TDS. The applicable economic factors, for the purposes of evaluation of Tenders shall be:

- (a) Adjustment for Deviations in the Delivery and Completion Schedule
- (b) Cost of major replacement components, mandatory spare parts, and service

52.6 Variations, deviations, and alternatives and other factors which are in excess of the requirements of the Tender Document or otherwise result in unsolicited benefits for the Purchaser will not be taken into account in Tender evaluation.

53. Assessing the Price of Unpriced Items

53.1 If it is so permitted under ITT Clause 23, any Tenderer offered only eighty percent (80%) or minimum percent of the items of a lot as stated under ITT Sub-Clause 23.5, the TEC shall calculate the total lot value by adding up the average prices offered by other responsive Tenderers for the missing items to the lot value to establish the winning lot Tender. If the Tenderer offered less than the specified, the Tender shall be evaluated as stated under ITT Clause 23.

53.2 If the winning lot is missing some items as stated under ITT Sub Clause 53.1, comprising less than twenty percent (20%), the Purchaser may procure the missing items from the Tenderer offering the least cost for those remaining items.

54. Evaluation of Domestic Preference

54.1 If the Tender document so specifies, the Tenderer will grant a margin preference to goods manufactured in Bangladesh as stated in ITT Clause 51 for the purpose of Tender comparison, in accordance with the procedure outlined below:

54.2 The Purchaser will first review the tenders to confirm the appropriateness of, and to modify as necessary, the tenderer group classification to which Tenderers assigned their tenders in preparing their Tender Forms and Price Schedules.

54.3 All evaluated tenders in each group will then be compared to determine the lowest evaluated tender of each group. Such lowest evaluated tenders shall be compared with each other and if as a result of this comparison a tenderer from Group A and the Tenders offering Goods manufactured in Bangladesh is the lowest, it shall be selected for the award.

54.4 If, as a result of the preceding comparison, the lowest evaluated tender is from Group B,

- (a) all Group B tenders will then be further compared with the lowest evaluated tender from Group A, after adding to the evaluated tender price of goods

offered in the tender for Group B, for the purpose of further comparison only an amount equal to fifteen (15) percent of the CIF/CIP (named place of destination or named port of destination) tender price.

- (b) The lowest-evaluated tender determined from this last comparison shall be selected for the award.

- 55. Price Comparison**
- 55.1 The TEC shall compare all responsive Tenders to determine the lowest-evaluated Tender, as stated under ITT Clause 54.
- 55.2 In the extremely unlikely event that there is a tie for the lowest evaluated price, the Tenderer with the superior past performance with the Purchaser shall be selected, whereby factors such as delivery period, quality of Goods delivered, complaints history and performance indicators could be taken into consideration.
- 55.3 In the event that there is a tie for the lowest price and none of the Tenderers has the record of past performance with the Purchaser, then the Tenderer shall be selected, subject to firm confirmation through the Post-qualification process described in ITT Clause 57, after consideration as to whether the quality of Goods that is considered more advantageous by the end-users.
- 55.4 The successful Tenderer as stated under ITT Sub Clauses 55.1, 55.2 and 55.3 shall not be selected through lottery under any circumstances.
- 56. Negotiation**
- 56.1 No negotiations shall be held during the Tender evaluation or award with the lowest or any other Tenderer pursuant to Rule 99 of the Public Procurement Rules, 2008.
- 57. Post-qualification**
- 57.1 After determining the lowest-evaluated responsive tender as stated under ITT Sub-Clause 55.1, the Purchaser's TEC pursuant to Rule 100 of the Public Procurement Rules, 2008, shall carry out the Post-Qualification of the Tenderer, using only the requirements specified in Sub-Section C, Qualification Criteria.
- 57.2 The TEC shall contact the references given by Tenderers about their previous Supply experiences to verify, if necessary, statements made by them in their Tender and to obtain the most up-to-date information concerning the Tenderers.
- 57.3 The TEC may visit the premises of the Tenderer as a part of the post-qualification process, if practical and appropriate, to verify information contained in its Tender.
- 57.4 The TEC shall determine to its satisfaction whether the Tenderer that is selected as having submitted the lowest evaluated responsive Tender is qualified to perform the Contract satisfactorily.
- 57.5 The objective of any visit under ITT Sub-Clause 57.3 shall be limited to a general and visual inspection of the Tenderer's facilities and its plant and equipment, and there shall be no discussion concerning the Tender or its evaluation with the Tenderer during such visit(s).

- 57.6 In the event that the Tenderer with lowest evaluated cost fails the post-qualification, the TEC shall make a similar determination for the Tenderer offering the next lowest evaluated cost and so on from the remaining responsive Tenders, provided that,
- (a) such action shall only be taken if the evaluated costs of the Tenders under consideration are acceptable to the Purchaser;
 - (b) when the point is reached whereby the evaluated costs of the remaining responsive Tenders are significantly higher than that of the official estimate, or the market price, the Purchaser may take action pursuant to Rule 33 and may proceed for re-Tendering, using a revised Tender Document designed to achieve a more successful result.

58. Rejection of All Tenders

58.1 The Purchaser may, in the circumstances as stated under ITT Sub-Clause 58.2 and pursuant to Rule 33 of the Public Procurement Rules 2008, reject all Tenders following recommendations from the Evaluation Committee only after the approval of such recommendations by the Head of the Purchaser.

58.2 All Tenders can be rejected, if -

- (a) the price of the lowest evaluated Tender exceeds the official estimate, provided the estimate is realistic; or
- (b) there is evidence of lack of effective competition; such as non-participation by a number of potential Tenderers; or
- (c) the Tenderers are unable to propose completion of the delivery within the stipulated time in its offer, though the stipulated time is reasonable and realistic; or
- (d) all Tenders are non-responsive; or
- (e) evidence of professional misconduct, affecting seriously the Procurement process, is established pursuant to Rule 127 of the Public Procurement Rules, 2008.

58.3 Notwithstanding anything contained in ITT Sub-Clause 58.2 Tenders may not be rejected if the lowest evaluated price is in conformity with the market price.

58.4 A Purchaser may pursuant to Rule 35 of the Public Procurement Rules, 2008, on justifiable grounds, annul the Procurement proceedings prior to the deadline for the submission of Tenders.

58.5 All Tenders received by the Purchaser shall be returned unopened to the Tenderers in the event Procurement proceedings are annulled under ITT Sub-Clause 58.4.

59. Informing Reasons for Rejection

59.1 Notice of the rejection, pursuant to Rule 35 of the Public Procurement Rules, 2008, will be given promptly within seven (7) days of decision taken by the Purchaser to all Tenderers and, the Purchaser will, upon receipt of a written request, communicate to any Tenderer the reason(s) for its rejection but is not required to justify those reason(s).

G. Contract Award

60. Award Criteria

60.1 The Purchaser shall award the Contract to the Tenderer whose offer is responsive to the Tender Document and that has been determined to be the lowest evaluated Tender, provided further that the Tenderer is determined to be Post-Qualified as stated under ITT Clause 57.

- 60.2 A Tenderer shall not be required, as a condition for award of contract, to undertake obligations not stipulated in the Tender Document, to change its price, or otherwise to modify its Tender.
- 61. Purchaser's Right to Vary Quantities** 61.1 The Purchaser reserves the right at the time of Contract Award to increase or decrease the quantity, per item, of Goods and Related Services originally specified in Section 6: Schedule of Requirements, provided this does not exceed the percentages indicated in the TDS, and without any change in the unit prices or other terms and conditions of the Tender and the Tender Document.
- 62. Notification of Award** 62.1 Prior to the expiry of the Tender validity period and within seven (7) working days of receipt of the approval of the award by the Approving Authority, the Purchaser pursuant to Rule 102 of the Public procurement Rules, 2008, shall issue the Notification of Award (NOA) to the successful Tenderer
- 62.2 The Notification of Award, attaching the contract as per the sample (Form PG4-7) to be signed, shall state:
- (a) the acceptance of the Tender by the Purchaser;
 - (b) the price at which the contract is awarded;
 - (c) the amount of the Performance Security and its format;
 - (d) the date and time within which the Performance Security shall be submitted; and
 - (e) the date and time within which the contract shall be signed.
- 62.3 The Notification of Award shall be accepted in writing by the successful Tenderer within seven (7) working days from the date of issuance of NOA.
- 62.4 Until a formal contract is signed, the Notification of Award shall constitute a Contract, which shall become binding upon the furnishing of a Performance Security and the signing of the Contract by both parties.
- 62.5 The Notification of Award establishes a Contract between the Purchaser and the successful Tenderer and the existence of a Contract is confirmed through the signature of the Contract Document that includes all agreements between the Purchaser and the successful Tenderer.
- 63. Performance Security** 63.1 The Performance Security shall be determined sufficient to protect the performance of the Contract pursuant to Rule 27 of the Public Procurement Rules, 2008.
- 63.2 Performance Security shall be furnished by the successful Tenderer in the amount specified in the TDS and **denominated in the currencies** in which the Contract Price is payable pursuant to Rule 102 (8) of the Public Procurement Rules, 2008.
- 63.3 The proceeds of the Performance Security shall be payable to the Purchaser unconditionally upon first written demand as compensation for any loss resulting from the Supplier's failure to complete its obligations under the Contract.
- 64. Form and Time Limit for furnishing of Performance security** 64.1 The Performance Security shall be in the form of irrevocable Bank Guarantee in the format (Form PG4-9) as stated under ITT Clause 63, **shall be issued by an internationally reputable bank and it shall have correspondent bank located in Bangladesh, to make it enforceable** pursuant to Rule 27(4) of the Public Procurement Rules, 2008..

64.2 Within twenty-eight (28) days from issue of the Notification of Award, the successful Tenderer shall furnish the Performance Security for the due performance of the Contract in the amount specified under ITT Sub Clause 63.2.

65. Validity of Performance Security

65.1 The Performance Security shall be required to be valid until a date twenty-eight (28) days beyond the date of completion of the Supplier's performance obligations under the Contract, including any warranty obligations.

65.2 If under any circumstances date of completion of the Supplier's performance obligations under the Contract, including any warranty obligations is to be extended, the Performance Security shall correspondingly be extended for the extended period.

66. Authenticity of performance Security

66.1 The Purchaser shall verify the authenticity of the Performance Security submitted by the successful Tenderer by sending a written request to the branch of the bank issuing irrevocable Bank Guarantee in specified format.

66.2 If the Performance Security submitted under ITT Sub Clause 63.2 is not found to be authentic, the Purchaser shall proceed to take measures against the Tenderer in accordance with Section 64 of the Act and pursuant to Rule 127 of the Public Procurement Rules, 2008.

67. Contract Signing

67.1 At the same time as the Purchaser issues the Notification of Award, the Purchaser shall send the draft Contract Agreement and all documents forming the Contract pursuant to Rule 102 of the Public Procurement Rule, 2008, to the successful Tenderer.

67.2 Within twenty-eight (28) days of the issuance of Notification of Award, the successful Tenderer and the Purchaser shall sign the contract provided that the Performance Security submitted by the Tenderer is found to be genuine.

67.3 If the successful Tenderer fails to provide the required Performance Security, as stated under ITT Clause 63 or to sign the Contract, as stated under ITT Sub-Clause 67.2, Purchaser shall proceed to award the Contract to the next lowest evaluated Tenderer, and so on, by order of ranking pursuant to Rule 102 of the Public Procurement Rules, 2008.

68. Publication of Notification of Award of Contract

68.1 Notification of Awards for Contracts of Taka 10(ten) million and above shall be notified by the Purchaser to the Central Procurement Technical Unit within 7(seven) days of issuance of the NOA for publication in their website, and that notice shall be kept posted for not less than a month pursuant to Rule 37 of the Public Procurement Rules, 2008.

68.2 Notification of Award for Contracts below Taka 10(ten) million, shall be published by the Purchaser on its Notice Board and where applicable on the website of the Purchaser and that notice shall be kept posted for not less than a month pursuant to Rule 37 of the Public Procurement Rules, 2008..

69. Debriefing of Tenderers

69.1 Debriefing of Tenderers by Purchaser shall outline the relative status and weakness only of his or her Tender requesting to be informed of the grounds for not accepting the Tender submitted by him or her pursuant to Rule 37 of the Public Procurement Rule, 2008, without disclosing information about any other Tenderer.

69.2 In the case of debriefing confidentiality of the evaluation process shall be maintained.

**70. Right to
Complain**

70.1 Any Tenderer has the right to complain if it has suffered or likely to suffer loss or damage due to a failure of a duty imposed on the Purchaser to fulfil its obligations in accordance with Section 29 of the Public Procurement Act 2006 and pursuant to Part 12 of Chapter Three of the Public Procurement Rules, 2008.

70.2 Circumstances in which a formal complaint may be lodged in sequence by a potential Tenderer against a Purchaser pursuant to Rule 56 of the Public Procurement Rules, 2008, and the complaints, if any, be also processed pursuant to Rule 57 of the Public Procurement Rules 2008.

70.3 The potential Tenderer shall submit his or her complaint in writing within seven (7) calendar days of becoming aware of the circumstances giving rise to the complaint.

70.4 In the first instance, the potential Tenderer shall submit his or her complaint to the Purchaser who issued the Tender Document.

70.5 The place and address for the first stage in the submission of complaints to the Administrative Authority is provided in the TDS.

70.6 The Tenderer may appeal to a Review Panel only if the Tenderer has exhausted all his or her options of complaints to the administrative authority as stated under ITT Sub-Clause 70.2.

Not For Submission

Section 2. Tender Data Sheet

Instructions for completing the Tender Data Sheet are provided, as needed, in the notes in italics and under lined mentioned for the relevant ITT clauses.

ITT Clause	Amendments of, and Supplements to, Clauses in the Instruction to Tenderers
A. General	
ITT 1.1	<p>The Purchaser is : Rural Power Company Limited.</p> <p>Representative: Executive Director (Engineering) Rural Power Company Ltd. House-19, Road-1/B, Sector-09, Uttara Model Town, Dhaka-1230, Bangladesh.</p> <p>Consignee: Plant In-charge, Mymensingh Power Station, Shambhuganj, Mymensingh, Bangladesh</p> <p>The Name and identification number of Tender are: <u>Name of Tender:</u> Name of Package-1: Procurement of Air Filters of GT and Generator for Mymensingh Power Station. Name of Package-2: Procurement of Bearings and Hardware of GT for Mymensingh Power Station. Identification number: PUR- 008(FG/MPS/OTM)/2020-2021, Dated: 24/09/2020</p>
ITT 1.2	<p>The number, identification and name of lots comprising the Tender are: Number of Package: 2 (Two) Identification and Name of Lots: Package-1, Lot-1: Procurement of Air Filters of GT and Generator for Mymensingh Power Station. Package-2, Lot-1: Procurement of GT Bearings for Mymensingh Power Station. Package-2, Lot-2: Procurement of GT Hardware for Mymensingh Power Station.</p>
ITT3.1	The source of fund is Own Fund of RPCL.
ITT3.3	The name of the Development Partner is “ None ”
ITT5.1	Tenderers from the following countries are not eligible: Israel
ITT6.1	Goods and Related Services from the following countries are not eligible: Israel

B. Tender Document	
ITT8.2	The following are the offices of the Purchaser or authorised agents for the purpose of providing the Tender Document: Executive Director (Finance & Accounts) Rural Power Company Ltd. House-19 (1 st Floor), Road-1/B, Sector-09, Uttara Model Town, Dhaka-1230, Bangladesh.
ITT 9.1	For clarification of Tender purposes only, the Purchaser's address is: Attention: Executive Director (Engineering) Address: Rural Power Company Ltd., House-19(2 nd Floor), Road-1/B, Sector-09, Uttara Model Town, Dhaka-1230, Bangladesh Telephone: +88 02 48961201 Fax: +88 02 48963229 Electronic mail address: edengg@rpcl.gov.bd
ITT10.1	The Pre- Tender meeting shall be held at RPCL Corporate Office on 08/10/2020; 11:00 BST.
C. Qualification Criteria	
ITT 13.1	The maximum three (3) number of arbitration awards against the Tenderer over a period of the last five (5) years.
ITT 14.1(a)	The Tenderer shall have a minimum of five (5) years of overall experience for supply of goods and related services.
ITT 14.1(b)	The satisfactory completion of supply of similar Goods under maximum 2 (Two) contracts in the last 5 (Five) years (i.e. years counting backward from the date of publication of Invitation for Tenders (IFT) in the newspaper) is as follows: Package-1, Lot-1: USD 1,20,000 or equivalent currency. Package-2, Lot-1: USD 80,000 or equivalent currency. Package-2, Lot-2: USD 50,000 or equivalent currency. [The Tenderer must submit evidence in the form of contract completion certificate issued by the end users.]
ITT 14.1(c)	The minimum supply and/or production capacity of Goods is/ are: “None”
ITT 15.1(a)	The minimum amount of liquid asset or working capital or credit facility is as following: Package-1, Lot-1: USD 1,80,000 or equivalent currency. Package-2, Lot-1: USD 1,20,000 or equivalent currency. Package-2, Lot-2: USD 70,000 or equivalent currency. [Tenderer must submit proper certificate mentioning the amount clearly]

ITT 16.2	The maximum of percentage <i>[state percentage]</i> of Goods allowed to be subcontracted: Not Applicable
D. Preparation of Tender	
ITT21.1(q)	<p>The Tenderer shall submit with its Tender the following additional documents:</p> <ul style="list-style-type: none"> i) Necessary technical literatures and leaflets/catalogue in English language including storing guidelines. ii) Documentary evidences as stated in ITT 14.1(a), 14.1(b) and 15.1(a) of TDS. iii) Manufacturer's/Tenderer's warranty certificate stating that the offered items are new, unused and of the most recent or current models, and that they incorporate all recent improvements in accordance with GCC 33.1 & will be fitted in the existing system and will operate satisfactorily during the warranty period as stated under GCC 33.3 of PCC. iv) The Original Tender document (which is issued in favour of the Tenderer by the Procuring Entity or its authorized agent) duly sealed and signed by the Tenderer or by the authorized representative of the Tenderer. v) Only for Package-1, Lot-1: Tenderer shall have to submit the sample of the filters and the test report of offered air filters from independent European/American standard testing laboratory as per design standard of EN 779:2012/ ASHRAE 52.2:2007 along with the tender. In the test report, name of the testing institute & design standard code no. should be mentioned clearly. The test of the filter should have been performed within last five years. The test report should be original or notary public certified photocopy. The sample will be examined by a committee appointed by the Head of Procuring Entity (HOPE) and must be accepted by the committee. For the sample not accepted by the committee, the offer of respective tenderer shall not be considered for further evaluation.
ITT22.1	Alternatives shall not be permitted.
ITT23.3	Tenders are being invited for single lot only.
ITT 23.5	Not applicable.
ITT 23.7	The following particular item represents more than fifty percent (50%) of the estimated lot value is: "None"
ITT 23.11(c) ITT 23.12 (c) ITT 23.13 (e)	"Final destination (Project Site)": Mymensingh Power Station, Shambhuganj, Mymensingh, Bangladesh.
ITT 23.12 (a)	Place of Destination: "Not Applicable"

ITT 23.12 (d)	<p>The prices of the Goods shall have to be quoted using the following Incoterms: Package-1, Lot-1: CPT any Seaport/Landport of Bangladesh as per Incoterm: 2020. Package-2, Lot-1: CPT Hazrat Shahjalal Int'l Airport, Dhaka as per Incoterm: 2020. Package-2, Lot-2: CPT Hazrat Shahjalal Int'l Airport, Dhaka as per Incoterm: 2020. Place of Destination: Mymensingh Power Station, Shambhugonj, Mymensingh, Bangladesh. Port of Destination: Package-1, Lot-1: Any Seaport/Landport of Bangladesh. Package-2, Lot-1: Hazrat Shahjalal International Airport, Dhaka. Package-2, Lot-2: Hazrat Shahjalal International Airport, Dhaka.</p>
ITT 24.3	Name of the foreign currency: USD/EUR . Conversion rate will be applicable as per Bangladesh Bank Exchange Rate on the date of opening of the tender.
ITT 25.2(b)	Spare parts are: Not required
ITT26.1(b)	<p>Manufacturer's authorization is: Required if the tender is not a manufacturer. A Manufacturer's authorization letter is required for the all items listed in section: 6 schedule of Requirements. [Authorization Letter from genuine Dealer/authorized distributor of the manufacturer will be accepted. In that case, authenticated documents in support of dealership/distributorship shall have to be submitted. Scanning Paper, E-mail copy, Faxed copy will not be allowed.]</p>
ITT 26.1(C)	After sales service is: Not required
ITT 27.2	The Tender validity period shall be 120 days
ITT 29.2	In favour of Rural Power Company Limited.
ITT29.3	<p>The amount of the Tender Security shall be as follows: Package-1, Lot-1: USD 3,000 / EUR 2,550/ BDT 2,55,000. Package-2, Lot-1: USD 2,000 / EUR 1,700/ BDT 1,70,000. Package-2, Lot-2: USD 1,200 / EUR 1,000/ BDT 1,00,000.</p>
ITT 34.1	In addition to the original of the Tender, 1 (One) copy shall be submitted.
E. Submission of Tender	
ITT 35.2(c)	<p>The inner and outer envelopes shall bear the following additional identification marks :</p> <ul style="list-style-type: none"> ▪ Tender Invitation Reference No. & Date: ▪ Name of Tender Package: ▪ No. & Name of Lot for which Tender being submitted: ▪ Name & Address of the Purchaser: ▪ Name & Address of the Tenderer:
ITT 35.7	Tenderer shall not have the option of submitting their tender electronically.
ITT 35.8	If bidders shall have the option of submitting their bids electronically, the electronic bidding submission procedures shall be: Not Applicable

ITT36.1	<p>For <u>Tender submission purposes</u>, the Purchaser's address is: Attention: Executive Director (Engineering) Address: Rural Power Company Limited, House No.19 (2nd floor), Road No. 1/B, Sector No. 09, Uttara Model Town, Dhaka-1230, Bangladesh. Deadline for submission of Tenders is: Package-1, Lot-1: 19-Nov-2020; 12:00 (BST) Package-2, Lot-1: 08-Nov-2020; 12:00 (BST) Package-2, Lot-2: 08-Nov-2020; 12:00 (BST)</p>
F. Opening and Evaluation of Tenders	
ITT42.2	<p>The Tender opening shall take place at: Address: Corporate Office of Rural Power Company Limited., House No.19 (3rd floor), Road No.1/B, Sector No.09, Uttara Model Town, Dhaka- 1230, Bangladesh. Opening Schedule of Tenders is: Package-1, Lot-1: 19-Nov-2020; 12:30 (BST) Package-2, Lot-1: 08-Nov-2020; 12:30 (BST) Package-2, Lot-2: 08-Nov-2020; 12:30 (BST)</p>
ITT 42.3	<p>If electronic tender submission is permitted as sated under ITT sub-clause 34.8, the specific tender opening procedures shall be: Not Applicable</p>
ITT 51.1	<p>Domestic preference shall not be a tender evaluation factor.</p>
ITT 52.5	<p>The applicable economic factors, for the purposes of evaluation of Tenders shall be: (a) <u>Adjustment for Deviations in the Delivery and Completion Schedule:</u> "The Goods covered by this Tendering process are required to be delivered in accordance with, and completed within, the Delivery and Completion Schedule specified in Section 6, Schedule of Requirements. No credit will be given for earlier completion. Tender offering late contract performance schedules within acceptable period will be accepted but the tenders shall be Adjusted in the evaluation by adding to the Tender Price at the rate of Zero point One (0.10%) Percent of the Tender Price for each day of delay. Tender offering delivery schedules beyond Sixty (60) days of the date specified in Section 6, Schedule of Requirement, shall be rejected." (b) <u>Cost of major replacement components, mandatory spare parts, and service :Not applicable</u></p>
G. Award of Contract	
ITT61.1	<p>The maximum percentage by which quantities per item may be increased/decreased: 20%</p>
ITT63.2	<p>The amount of Performance Security shall be Ten (10%) percent of the Contract Price.</p>
ITT70.5	<p>The name and address of the office where complaints to the Purchaser are to be submitted is: Attention: Executive Director (Engg.), Rural Power Company Limited. Address: House No.19, Road No.1/B, Sector No. 09, Uttara Model Town, Dhaka-1230, Bangladesh.</p>

Section 3. General Conditions of Contract

1. Definitions

- 1.1 The following words and expressions shall have the meaning hereby assigned to them. Boldface type is used to identify the defined term:
- (a) **Completion Schedule** means the fulfilment of the Related Services by the Supplier in accordance with the terms and conditions set forth in the Contract;
 - (b) **Contract Agreement** means the Agreement entered into between the Purchaser and the Supplier, together with the Contract Documents referred to therein, including all attachments, appendices, and all documents incorporated by reference therein;
 - (c) **Contract Documents** means the documents listed in the Contract Agreement, including any amendments thereto;
 - (d) **Contract Price** means the price stated in the Notification of Award and thereafter as adjusted in accordance with the provisions of the Contract;;
 - (e) **Day** means calendar days unless otherwise specified as working days;
 - (f) **Delivery** means the transfer of ownership of the Goods from the Supplier to the Purchaser in accordance with the terms and conditions set forth in the Contract;
 - (g) **GCC** mean the General Conditions of Contract;
 - (h) **Goods** means raw materials, products and equipment and objects in solid, liquid or gaseous form, electricity, and related Services if the value of such Services does not exceed that of the Goods themselves;
 - (i) **Government** means the Government of the People's Republic of Bangladesh;
 - (j) **Procuring Entity/Purchaser** means a Entity having administrative and financial powers to undertake Procurement of Goods, Works or Services using public funds, as specified in the PCC;
 - (k) **Related Services** means Services linked to the supply of Goods contracts.;
 - (l) **PCC** means the Particular Conditions of Contract;
 - (m) **Subcontractor** means any natural person, private or government entity, or a combination of the above, to whom any part of the Goods to be supplied or execution of any part of the Related Services is subcontracted by the Supplier;
 - (n) **Supplier** means a Person under contract with a Purchaser for the supply of Goods and related Services under the Act;
 - (o) **Site** means the point(s) of delivery named in the PCC
 - (p) **Writing** means communication written by hand or machine duly signed and includes properly authenticated messages by facsimile or electronic mail.
 - (q) **Verified Report** means the report submitted by the Purchaser to the Head of the Purchaser setting forth its findings as to the existence of grounds or causes for termination and explicitly stating its

recommendation for the issuance of a Notice to Terminate.

- 2. Contract Documents**
- 2.1 Subject to the order of precedence set forth in the GCC Sub-Clause 5.1, all documents forming the Contract (and all parts thereof) are intended to be correlative, complementary, and mutually explanatory. The Contract Agreement shall be read as a whole.
- 3. Corrupt, Fraudulent, Collusive or Coercive Practices**
- 3.1 The Government requires that Purchaser, as well as Suppliers, shall observe the highest standard of ethics during the implementation of procurement proceedings and the execution of contracts under public funds.
- 3.2 The Government requires that Procuring Entities, as well as Suppliers shall, during the execution of Contracts under public funds, ensure-
- (a) strict compliance with the provisions of Section 64 of the Public Procurement Act 2006 (Act 24 of 2006);
 - (b) abiding by the code of ethics as mentioned in the Rule 127 of the Public Procurement Rules, 2008;
 - (c) that neither it nor any other member of its staff or any other agents or intermediaries working on its behalf engages in any practice as detailed in GCC Sub -Clause 3.3
- 3.3 For the purpose of GCC Sub-clause 3.2 the terms –
- (a) **corrupt practice** means offering, giving or promising to give, receiving, or soliciting, either directly or indirectly, to any officer or employee of a Purchaser or other public or private authority or individual, a gratuity in any form; employment or any other thing or service of value as an inducement with respect to an act or decision or method followed by a Purchaser in connection with a Procurement proceeding or contract execution;
 - (b) **fraudulent practice** means the misrepresentation or omission of facts in order to influence a decision to be taken in a Procurement proceeding or Contract execution;
 - (c) **collusive practice** means a scheme or arrangement between two (2) or more Persons, with or without the knowledge of the Purchaser, that is designed to arbitrarily reduce the number of Tenders submitted or fix Tender prices at artificial, noncompetitive levels, thereby denying a Purchaser the benefits of competitive price arising from genuine and open competition; or
 - (d) **coercive practice** means harming or threatening to harm, directly or indirectly, Persons or their property to influence a decision to be taken in a Procurement proceeding or the execution of a Contract, and this will include creating obstructions in the normal submission process used for Tenders.

3.4 Should any corrupt, fraudulent, collusive or coercive practice of any kind come to the knowledge of the Purchaser, it will, in the first place, allow the Supplier to provide an explanation and shall, take actions only when a satisfactory explanation is not received. Such exclusion and the reasons thereof, shall be recorded in the record of the procurement proceedings and promptly communicated to the Supplier concerned. Any communications between the Supplier and the Purchaser related to matters of alleged fraud or corruption shall be in writing.

3.5 If corrupt, fraudulent, collusive or coercive practices of any kind determined by the Purchaser against the Supplier alleged to have carried out such practices, the Purchaser shall proceed under GCC Clause 42.4

3.6 The Supplier shall permit the Purchaser to inspect the Supplier's accounts and records and other documents relating to the submission of the Tender and Contract performance.

4. Interpretation

4.1 In interpreting the GCC, singular also means plural, male also means female or neuter, and the other way around. Headings in the GCC shall not be deemed part thereof or be taken into consideration in the interpretation or construction thereof or of the Contract. Words have their normal meaning under the English language unless specifically defined.

4.2 Entire Agreement

(a) The Contract constitutes the entire agreement between the Purchaser and the Supplier and supersedes all communications, negotiations and agreements (whether written or oral) of parties with respect thereto made prior to the date of Contract Agreement; except those stated under GCC Sub Clause 5.1(i) .

4.3 Amendment

(a) No amendment or other variation of the Contract shall be valid unless it is in writing, is dated, expressly refers to the Contract, and is signed by a duly authorised representative of each party thereto.

4.4 Non-waiver

(a) Subject to GCC Sub-Clause 4.4(b), no relaxation, forbearance, delay, or indulgence by either party in enforcing any of the terms and conditions of the Contract or the granting of time by either party to the other shall prejudice, affect, or restrict the rights of that party under the Contract, neither shall any waiver by either party of any breach of Contract operate as waiver of any subsequent or continuing breach of Contract.

(b) Any waiver of a party's rights, powers, or remedies under the Contract must be in writing, dated, and signed by an authorised representative of the party granting such waiver, and must specify the right and the extent to which it is being waived.

4.5 Severability

(a) If any provision or condition of the Contract is prohibited or rendered invalid or unenforceable, such prohibition, invalidity or unenforceability shall not affect the validity or enforceability of any

other provisions and conditions of the Contract.

- 5. Documents Forming the Contract in order of precedence**
- 5.1 The following documents forming the Contract shall be in the following order of precedence, namely :
- (a) the signed Contract Agreement;
 - (b) the Notification of Award;
 - (c) The Tender and the appendices to the Tender;
 - (d) Particular Conditions of Contract;
 - (e) General Conditions of Contract;
 - (f) Technical Specifications;
 - (g) Drawings;
 - (h) Priced Schedule and schedule of requirements and ;
 - (i) Other Documents including correspondences listed in the PCC forming part of the Contract.
- 6. Eligibility**
- 6.1 The Supplier and its Subcontractors shall have the nationality of an eligible country. A Supplier or Subcontractor shall be deemed to have the nationality of a country if it is a citizen or constituted, incorporated, or registered, and operates in conformity with the provisions of the laws of that country.
- 6.2 All Goods and Related Services to be supplied under the Contract shall have their origin in Eligible Countries.
- 6.3 For the purpose of the GCC Clause 6.2, origin means the country where the goods have been grown, mined, cultivated, produced, manufactured, or processed; or through manufacture, processing, or assembly, another commercially recognized article results that differs substantially in its basic characteristics from its components.
- 7. Governing Language**
- 7.1 The Contract shall be written in English language. Correspondence and documents relating to the Contract exchanged by the Supplier and the Purchaser shall be written in English. Supporting documents and printed literature that are part of the Contract may be in another language provided they are accompanied by an accurate translation of the relevant passages in English language, in which case, for purposes of interpretation of the Contract, this translation shall govern.
- 7.2 The Supplier shall bear all costs of translation to the governing language and all risks of the accuracy of such translation.
- 8. Governing Law**
- 8.1 The Contract shall be governed by and interpreted in accordance with the laws of the People's Republic of Bangladesh.
- 9. No fees/Gratuities**
- 9.1 No fees, gratuities, rebates, gifts, commissions or other payments, other than those shown in the Tender or the contract, shall be given or received in connection with the procurement process or in the contract execution.

-
- 10. Use of Contract Documents & Information**
- 10.1 The Supplier shall not, except for purposes of performing the obligations in this Contract, without the Purchaser's prior written consent, disclose this Contract, or any provision thereof, or any specification, plan, drawing, pattern, sample, or information furnished by or on behalf of the Purchaser. Any such disclosure shall be made in confidence and shall extend only as far as may be necessary for purposes of such performance.
- 10.2 Any document, other than this Contract itself, enumerated in GCC Clause 10.1 shall remain the property of the Purchaser and shall be returned (all copies) to the Purchaser on completion of the Supplier's performance under this Contract if so required by the Purchaser.
- 11. Communications & Notices**
- 11.1 Communications between Parties (notice, request or consent required or permitted to be given or made by one party to the other) pursuant to the Contract shall be in writing to the addresses specified in the PCC.
- 11.2 A notice shall be effective when delivered or on the notice's effective date, whichever is later.
- 11.3 A Party may change its address for notice hereunder by giving the other Party notice of such change to the address.
- 12. Trademark, Patent and Intellectual Property Rights**
- 12.1 The Purchaser should not be liable for any infringement of intellectual property rights arising from use of the goods procured. In case there are third-party claims of such infringement of patent, trademark, or industrial design rights, the supplier must indemnify and hold the Purchaser free and harmless against such claims and shall not be in contravention of **The Trademark Act, 2009 and The Patents and Designs Act, 1911.**
- 13. Copyright**
- 13.1 The copyright in all drawings, documents, and other materials containing data and information furnished to the Purchaser by the Supplier herein shall remain vested in the Supplier, or, if they are furnished to the Purchaser directly or through the Supplier by any third party, including suppliers of materials, the copyright in such materials shall remain vested in such third party.
- 14. Assignment**
- 14.1 The Supplier shall not assign his rights or obligations under the Contract, in whole or in part, except with the Purchaser's prior written consent.
- 15. Sub-contracting**
- 15.1 Any subcontracting arrangements made during contract implementation and not disclosed at the time of the Tendering shall not be allowed.
- 15.2 Subcontracting of any portion of the Goods shall not relieve the Tenderer from any liability or obligations that may arise from its performance.
- 15.3 Supplier shall retain full responsibility for the contract and cannot pass any contractual obligations to the subcontractor and under no circumstances assignment of the contract to the subcontractor be allowed.
- 15.4 Subcontractors shall comply with the provisions of GCC Clause 3 and 6.
- 16. Supplier's Responsibilities**
- 16.1 The Supplier shall supply all the Goods and Related Services specified in the Scope of Supply as stated under GCC Clause 18 and the Delivery and Completion schedule, as stated under GCC Clauses 23 and 24 in conformity with the provisions of the Contract Agreement.

17. Purchaser's Responsibilities

17.1 Whenever the performance of the obligations in this Contract requires that the Supplier obtain permits, approvals and other license from local public authorities, the Purchaser may, if so needed by the Supplier, make its best effort to assist the Supplier in complying with such requirements in a timely and expeditious manner. However, the supplier shall bear the costs of such permits and/or licenses. On the other hand, the Purchaser shall pay all costs involved in the performance of its responsibilities, in accordance with the contract.

17.2 The Purchaser shall pay the Supplier, in consideration of the provision of Goods and Related Services, the Contract Price under the provisions of the Contract at the times and manner prescribed in the Contract Agreement.

18. Scope of Supply

18.1 Subject to the PCC, the Goods and Related Services to be supplied shall be as specified in Section 6: Schedule of Requirements.

18.2 Unless otherwise stipulated in the Contract, the Scope of Supply shall include all such items not specifically mentioned in the Contract but that can be reasonably inferred from the Contract as being required for attaining Delivery and Completion of the Goods and Related Services as if such items were expressly mentioned in the Contract.

19. Amendment to Order

19.1 The Purchaser may make an amendment to Order for necessary adjustment within the general scope of the contract in any one or more of the following aspects in order to fully meet the requirement of the Contract:

- (a) Drawing, design or specifications of the goods, provided that:
 - i. The goods to be furnished are to be specifically manufactured for the government in accordance therewith;
 - ii. The change is an improvement of the goods and advantageous to the Government;
 - iii. It is done at no extra cost; and
 - iv. It is not prejudicial to the losing Tenderers in the sense that such change/s could not have been foreseen during the conduct of the tendering and would have significantly affected the other tenderer's tender;
- (b) The place of delivery;
- (c) The place of performance of the services;
- (d) Additional items needed and necessary for the protection of the goods procured, which were not included in the original contract.

19.2 Such amendment may or may not result to an increase or a decrease of the contract price, and/or an extension or reduction of the delivery period. However, the amendment should not have the result of changing the subject matter of the contract or the specifications of the goods or services, in any material aspect and to such an extent that, if introduced during the Tendering stage, may have had a significant effect on other Tenderer's tender, because this situation would actually require another tendering activity.

20. Instances When Amendment to Order May be Issued

- 20.1 The Purchaser may issue amendments order at any time during contract implementation, through a notice as stated under GCC Clause 11, provided that such adjustment is required to fully meet the requirements of the contract. Any of the following circumstances may serve as basis for such amendment/s:
- (a) Emergency cases, fortuitous events or unforeseen contingencies arising during contract implementation, and such contingencies have an impact on the procurement at hand, such as:
 - i. Changes in the conditions affecting the contract, e.g., a change in the place of delivery;
 - ii. Time is of the essence in the implementation of the contract, and any changes require immediate implementation; and
 - iii. Additional requirements have been identified as necessary for the protection of the goods procured, such as changes in the packaging of the goods, or additional items have become necessary to ensure that the goods are sufficiently protected from the elements;
 - (b) When the contract does not reflect the real intention of the parties due to mistake or accident, and the amendment is necessary to reflect the party's intention; and
 - (c) Other analogous circumstances that could affect the conditions of the procurement at hand

21. Adjustments in Contract Price and/or Delivery Schedule in Amendment to Order

- 21.1 If an amendment to order increases or decreases the cost of ,or the time required for executing any part of the delivery under the original contract, an equitable adjustment in contract price and/or delivery schedule should be mutually agreed upon between parties concerned, and the contract should be modified as stated under GCC Clause 46
- 21.2 If the amendment to order consists of additional items, the price adjustment shall be based on the unit price in the original contract for items of goods similar to those in the original contract. If the contract does not contain any rate applicable to the additional items, then suitable prices shall be mutually agreed upon between the parties, based on prevailing market prices.
- 21.3 It is required, however, that any increase in contract price must not exceed ten percent (10%) of the original contract price.

22. Packing and Documents

- 22.1 The Supplier shall provide such packing of the goods as is required to prevent their damage or deterioration during transit to their final destination, as indicated in the Contract and in accordance with existing industry standards. The packing shall be sufficient to withstand, without limitation, rough handling and exposure to extreme temperatures, salt and precipitation, and open storage. Packing case size and weights shall take into consideration, where appropriate, the remoteness of the goods' final destination and the absence of heavy handling facilities at all points in transit.
- 22.2 The packing, marking, and documentation within and outside the packages shall comply strictly with such special requirements as shall be expressly provided for in the Contract as stated under GCC Clause 22.1, including additional requirements, if any, specified in the PCC, and in any subsequent instructions ordered by the Purchaser.

-
- 22.3 The outer packaging must contain a “Packing List” which must reflect the actual contents of the package.
- 23. Delivery and Documents**
- 23.1 Subject to GCC Sub-Clause 19, the Delivery of the Goods and completion of the Related Services shall be in accordance with the Delivery and Completion Schedule specified in the Section 6: Schedule of Requirements.
- 23.2 The details of shipping and other documents to be furnished by the Supplier shall be specified in the PCC, and shall be received by the Purchaser at least one week before arrival of the Goods and, if not received the Supplier shall be responsible for consequent expenses.
- 24. Acceptance**
- 24.1 Acceptance by the Purchaser shall be completed not later than fourteen (14) days from receipt of the goods at final destination in the form of an **Acceptance Certificate**, unless any defects in the supply, any damage during transportation or any failure to meet the required performance criteria of the supply are identified and reported to the Supplier as stated under GCC Clause 31 and GCC Clause 32. In such cases the Acceptance Certificate will be issued only for those parts of the contract supplies which are accepted. The Acceptance Certificate for the remaining supplies will only be issued after the Supplier has remedied the defects and/or any non-conformity under GCC Clause 31 and GCC Clause 32.
- 24.2 The appropriate Technical Inspection and Acceptance Committee of the Purchaser must commence the inspection and acceptance process within two (2) days from delivery of the goods, and shall complete the same as soon as practicable.
- 25. Contract Price**
- 25.1 The Contract Price shall be specified in the PCC.
- 25.2 During evaluation, tender has excluded and not taken into account:
- (a) In the case of Goods manufactured in Bangladesh, VAT payable on account of Supplier, which will be payable on the goods if a contract is awarded to the Tenderer;
- (b) in the case of Goods manufactured outside the Bangladesh, already imported or to be imported, customs duties, import VAT and other import taxes levied on the imported Good, VAT, which will be payable on the Goods if the contract is awarded to the Tenderer.
- 25.3 The Contract price will include all the costs paid or payable as stated under GCC Clause 25.2.
- 25.4 Prices charged by the Supplier for the Goods delivered and the Related Services performed under the Contract shall not vary from the price as stated under GCC Sub-Clause 25.1, with the exception of any change in price resulting from a Change Order issued under GCC Clause 19.
- 26. Transportation**
- 26.1 The Supplier is required under the Contract to transport the Goods to a specified place of destination as specified in Section 6: Schedule of Requirements, defined as the Site, transport to such place of destination, including insurance, other incidental costs, and temporary storage, if any. These costs shall be included in the Contract Price.

-
- 26.2 If not in accordance GCC Clause 26.1, responsibility for transportation of the Goods shall be as specified in the **INCOTERM** indicated in the Price Schedule or any other trade terms specify the responsibilities of the Purchaser and Supplier as specified in PCC.
- 27. Terms of Payment**
- 27.1 The Contract Price, including any Advance Payments, if applicable, shall be paid in the manner as specified in the PCC.
- 27.2 The Supplier's request for payment shall be made to the Purchaser in writing, accompanied by an invoice describing, as appropriate, the Goods delivered and Related Services performed, and accompanied by the documents as stated under GCC Clause 23 and 24 and upon fulfilment of any other obligations stipulated in the Contract.
- 27.3 Payments shall be made promptly by the Purchaser, but in no case later than the days indicated in the PCC after submission of an invoice or request for payment by the Supplier, and after the Purchaser has accepted it.
- 27.4 The currencies in which payments shall be made to the Supplier under this Contract shall be those in which the tender price is expressed.
- 27.5 In the event that the Purchaser fails to pay the Supplier any payment by its respective due date or within the period set forth in the PCC, the Purchaser shall pay to the Supplier interest on the amount of such delayed payment at the rate shown in the PCC, for the period of delay until payment has been made in full, whether before or after judgment or arbitration award.
- 28. Insurance**
- 28.1 The Goods supplied under this Contract shall be fully insured by the Supplier in a freely convertible currency against loss or damage incidental to manufacture or acquisition, transportation, storage, and delivery. The Goods remain at the risk and title of the Supplier until their final acceptance by the Purchaser.
- 28.2 If not in accordance GCC Clause 28.1, the insurance coverage shall be as specified in the **INCOTERM** indicated in the Price Schedule or any other insurance provisions as specified in PCC.
- 29. Taxes and Duties**
- 29.1 For Goods Manufactured within Bangladesh, the Supplier shall be entirely responsible for all taxes, duties, VAT, license fees, and other such levies imposed or incurred until delivery of the contracted goods to the Purchaser.
- 29.2 For Goods manufactured outside Bangladesh, the Supplier shall be entirely responsible for all taxes, duties and other such levies imposed outside Bangladesh.
- 29.3 If any tax exemptions, reductions, allowances or privileges may be available to the Supplier in Bangladesh, the Purchaser shall use its best efforts to enable the Supplier to benefit from any such tax savings to the maximum allowable extent.
- 30. Performance Security**
- 30.1 The proceeds of the Performance Security shall be payable to the Purchaser as compensation for any loss resulting from the Supplier's failure to complete its obligations under the Contract.
- 30.2 The Performance Security shall be discharged by the Purchaser and returned to the Supplier not later than Thirty (30) days following the date of Completion of the Supplier's performance obligations under the Contract and the issuance of certification to that effect by the Purchaser, including any warranty obligations as stated under GCC Clause 33, provided that there are no claims filed against the supplier.

31. Specifications and Standards

- 31.1 The Goods and Related Services supplied under this Contract shall conform to the technical specifications and standards mentioned in Section 7, Technical Specification and in Section 8, Drawings, if any.
- 31.2 If there is no applicable standard, the goods must conform to the authoritative standards appropriate to the good's country of origin. Such standards must be the latest issued by the concerned institution.
- 31.3 Subject to the GCC Clause 19, the Supplier shall be entitled to disclaim responsibility for any design, data, drawing, specification or other document, or any modification thereof provided or designed by or on behalf of the Purchaser, by giving a notice of such disclaimer to the Purchaser.
- 31.4 Wherever references are made in the Contract to codes and standards in accordance with which it shall be executed, the edition or the revised version of such codes and standards shall be those specified in the Technical Specification. During Contract execution, any changes in any such codes and standards shall be applied only after approval by the Purchaser and shall be treated under GCC Clause 19.

32. Inspections and Tests

- 32.1 The Purchaser shall have the right to test the Goods to confirm their conformity to the Contract specifications. The PCC and Technical specifications shall specify what tests the Purchaser requires and where they are to be conducted. The supplier shall at its own expense and at no cost to the Purchaser, carry out all such tests of the Goods and related services as are specified in the Contract.
- 32.2 The Supplier shall provide the Purchaser with a report of the results of any such test.
- 32.3 The Purchaser may engage external agents for the purpose of conducting inspection or pre-shipment inspection of Goods, provided that the Purchaser shall bear all of its costs and expenses.
- 32.4 The Purchaser or its designated representative as specified shall be entitled to attend the tests and/or inspections under GCC Clause 32.1, provided that the Purchaser shall bear all of its own costs and expenses incurred in connection with such attendance.
- 32.5 Whenever the Supplier is ready to carry out any such test and inspection, it shall give a reasonable advance notice, including the place and time, to the Purchaser. The Supplier shall obtain from any relevant third party or manufacturer any necessary permission or consent to enable the Purchaser or its designated representative to attend the test and/or inspection.
- 32.6 The Purchaser may require the Supplier to carry out any test and/or inspection not required by the Contract, but deemed necessary to verify that the characteristics and performance of the Goods comply with the technical specifications, codes and standards under the Contract, provided that the Supplier's reasonable costs and expenses incurred in the carrying out of such test and/or inspection shall be added to the Contract Price. Further, if such test and/or inspection impede the progress of manufacturing and/or the Supplier's performance of its other obligations under the Contract, due allowance will be made in respect of the Delivery Dates and Completion Dates and the other obligations so affected.
- 32.7 The Purchaser may reject any Goods or any part thereof that fail to pass any test and/or inspection or do not conform to the specifications. The Supplier

shall either rectify or replace such rejected Goods or parts thereof or make alterations necessary to meet the specifications at no cost to the Purchaser, and shall repeat the test and/or inspection, at no cost to the Purchaser, upon giving a notice under GCC Sub-Clause 32.5.

32.8 The Supplier agrees that neither the execution of a test and/or inspection of the Goods or any part thereof, nor the attendance by the Purchaser or its representative, nor the issue of any report as stated under GCC Sub-Clause 32.2, shall relieve the Supplier from any warranties or other obligations under the Contract.

33. Warranty

33.1 The Supplier warrants that all the Goods supplied under the Contract are new, unused, and of the most recent or current models, and that they incorporate all recent improvements in design and materials, except when the design and/or material required by the Purchaser provides otherwise under GCC Clause 19.

33.2 The Supplier further warrants that the all Goods supplied under this Contract shall have no defect, arising from design, materials, or workmanship or from any act or omission of the Supplier that may develop under normal use of the supplied Goods in the conditions prevailing in Bangladesh.

33.3 In order to assure that manufacturing defects shall be corrected by the Supplier, manufacturer, or distributor, as the case may be, a warranty shall be required from the Supplier for a minimum period of three (3) months in the case of supplies, and one (1) year in the case of equipment, or other such period as may be specified in the PCC, after the Goods, or any portion thereof as the case may be, have been delivered to and accepted in the form of an **Acceptance Certificate** as indicated in the GCC Clause 24.1 at the final destination indicated in the PCC

33.4 The warranty periods may vary among the various items and lots. The warranty for Goods delivered ahead will lapse earlier than the succeeding deliveries.

33.5 The Purchaser shall promptly notify the Supplier in writing of any claims arising under this warranty.

33.6 Upon receipt of such notice, the Supplier shall, within the period specified in the PCC, expeditiously repair or replace the defective Goods or parts thereof, at no cost to the Purchaser.

33.7 If the Supplier, having been notified, fails to remedy the defect(s) within the period as stated under GCC Sub Clause 33.6, the Purchaser may proceed to call upon the Performance security without prejudice to any other rights which the Purchaser may have against the Supplier under the Contract and under the applicable law.

-
- 33.8 Performance Security under GCC Clause no 30 shall only be released after the lapse of the warranty period, provided that the goods supplied are free from patent and latent defects and all the conditions imposed under the contract have been fully met.
- (a) A patent defect, which is one that is apparent to the buyer on normal observation. It is an apparent or obvious defect.
 - i. For example, a ball pen that does not write is patently defective.
 - (b) A latent defect, which is one that is not apparent to the buyer by reasonable observation. A latent defect is “hidden” or one that is not immediately determinable.
 - i. For example, a ball pen that writes .75 kilometers instead of the expected 1.5 kilometers, has a latent defect.
- 34. Delays in Delivery and Extensions of Time**
- 34.1 The Supplier must deliver the Goods or perform the services procured within the period prescribed by the Purchaser, as specified in the Contract.
- 34.2 If at any time during performance of the Contract, the Supplier or its subcontractors should encounter conditions impeding timely delivery of the Goods or completion of Related Services as stated under GCC Clause 23, the Supplier shall promptly notify the Purchaser in writing. It must state therein the cause/s and duration of the expected delay. The Purchaser shall decide whether and by how much to extend the time. In all cases, the request for extension should be submitted before the lapse of the original delivery date.
- 34.3 Within twenty-one (21) days of receipt of the Supplier’s notice, the Purchaser shall evaluate the situation and may grant time extensions, if based on justifiable grounds, without liquidated damages.
- 34.4 The Procuring may extend up to twenty percent (20%) of the original contract time, above 20% of the original contract time approval of Head of Purchaser (HOPE) shall be required, in which case the extension shall be ratified by the Parties by amendment of the Contract as stated under GCC Clause 46.
- 34.5 Except in the case of Force Majeure, as provided under GCC Clause 38, a delay by the Supplier in the performance of its Delivery and Completion obligations shall render the Supplier liable to the imposition of liquidated damages as stated under GCC Clause 35, unless an extension of time is agreed upon, under GCC Sub-Clause 34.3.
- 35. Liquidated Damages**
- 35.1 Subject to GCC Clause 34 and 38, if the , if the Supplier fails to deliver any or all of the Goods by the Date(s) of delivery and/or perform the Related Services within the period specified in the Contract as stated under GCC Clause 23, the Purchaser shall, without prejudice to all its other remedies under the Contract, deduct from the Contract Price, as liquidated damages, a sum equivalent to the percentage specified in the PCC of the Contract price of the delayed Goods or unperformed / Related Services for each week or part thereof of delay until actual delivery or performance, up to a maximum deduction of the percentage specified in those PCC. Once the maximum is reached, the Purchaser may terminate the Contract as stated under GCC Clause 42.
- 36. Limitation of Liability**
- 36.1 Except in cases of criminal negligence or wilful misconduct, and in the case of infringement of patent and intellectual property rights, if applicable, the Supplier shall not be liable to the Purchaser, whether in contract, tort, or otherwise, for any indirect or consequential loss or damage, loss of use, loss of production, or loss of profits or interest costs, the aggregate liability of the Supplier to the Purchaser shall not exceed the

total Contract Price, provided that this limitation shall not apply, to the cost of repairing or replacing defective equipment or, to any obligation of the Supplier to pay liquidated damages to the Purchaser.

37. Change in Laws and Regulations

37.1 Unless otherwise specified in the Contract, if after the Contract, any law, regulation, ordinance, order or bylaw having the force of law is enacted, promulgated, abrogated, or changed in Bangladesh (which shall be deemed to include any change in interpretation or application by the competent authorities) that subsequently affects the Delivery Date and/or the Contract Price, then such Delivery Date and/or Contract Price shall be correspondingly increased or decreased, to the extent that the Supplier has thereby been affected in the performance of any of its obligations under the Contract.

38. Definition of Force Majeure

38.1 In this Clause, "Force Majeure" means an exceptional event or circumstance:

- (a) which is beyond a Party's control;
- (b) which such Party could not reasonably have provided against before entering into the Contract;
- (c) which, having arisen, such Party could not reasonably have avoided or overcome; and
- (d) which is not substantially attributable to the other Party.

38.2 Force Majeure may include, but is not limited to, exceptional events or circumstances of the kind listed below, so long as conditions (a) to (d) above are satisfied:

- (i) war, hostilities (whether war be declared or not), invasion, act of foreign enemies;
- (ii) rebellion, terrorism, sabotage by persons other than the Contractor's Personnel, revolution, insurrection, military or usurped power, or civil war;
- (iii) riot, commotion, disorder, strike or lockout by persons other than the Contractor's Personnel;
- (iv) munitions of war, explosive materials, ionising radiation or contamination by radio-activity, except as may be attributable to the Contractor's use of such munitions, explosives, radiation or radio-activity, and
- (v) natural catastrophes such as cyclone, hurricane, typhoon, tsunami, storm surge, floods, earthquake, landslides, fires, epidemics, quarantine restrictions, or volcanic activity;
- (vi) freight embargoes;
- (vii) acts of the Government in its sovereign capacity.

39. Notice of Force Majeure

39.1 If a Party is or will be prevented from performing its substantial obligations under the Contract by Force Majeure, then it shall give notice to the other Party of the event or circumstances constituting the Force Majeure and shall specify the obligations, the performance of which is or will be prevented. The notice shall be given within 14 days after the Party became aware, or should have become aware, of the relevant event or circumstance constituting Force Majeure.

39.2 The Party shall, having given notice, be excused performance of its obligations for so long as such Force Majeure prevents it from performing them.

39.3 Notwithstanding any other provision of this Clause, Force Majeure shall not apply to obligations of either Party to make payments to the other Party under

the Contract.

- 40. Duty to Minimize Delay**
- 40.1 Each Party shall at all times use all reasonable endeavours to minimise any delay in the performance of the Contract as a result of Force Majeure.
- 40.2 A Party shall give notice to the other Party when it ceases to be affected by the Force Majeure.
- 41. Consequences of Force Majeure**
- 41.1 The Supplier shall not be liable for forfeiture of its Performance Security, liquidated damages, or termination for default if and to the extent that its delay in performance or other failure to perform its obligations under the Contract is the result of an event of Force Majeure.
- 41.2 The Purchaser may suspend the delivery or contract implementation, wholly or partly, by written order for a certain period of time, as it deems necessary due to force majeure as defined in the contract.
- 41.3 Delivery made either upon the lifting or the expiration of the suspension order. However, if the Purchaser terminates the contract as stated under GCC clause 42, resumption of delivery cannot be done.
- 41.4 Head of Purchaser determines the existence of a force majeure that will be basis of the issuance of suspension of order.
- 41.5 Adjustments in the delivery or contract schedule and/or contract price, Including any need to modify contract under GCC Clause 46.
- 42. Termination for Default**
- 42.1 The Purchaser shall terminate this Contract for default when any of the following conditions attends its implementation:
- (a) Outside of force majeure, the Supplier fails to deliver or perform any or all of the GOODS within the period(s) specified in the contract, or within any extension thereof granted by the Purchaser pursuant to a request made by the Supplier prior to the delay;
 - (b) As a result of force majeure, the Supplier is unable to deliver or perform any or all of the GOODS, amounting to at least ten percent (10%) of the contract price, for a period of not less than sixty (60) calendar days after receipt of the notice from the Purchaser stating that the circumstance of force majeure is deemed to have ceased; or
 - (c) The Supplier fails to perform any other obligation under the Contract;
 - (d) If the Supplier, in the judgment of the Purchaser has engaged in corrupt, fraudulent, collusive or coercive practices, as stated under GCC Clause 3, in competing for or in executing the Contract;
 - (e) When deductible amount due to liquidated damage reaches its maximum as stated under GCC Clause 35.
- 42.2 Termination of a contract for default is without prejudice to other remedies available to the Purchaser for breach of contract, such as payment of liquidated and other damages, if there are grounds for the latter.
- 42.3 In the event the Purchaser terminates the Contract in whole or in part, as stated under GCC Clause 42.1, the Purchaser may procure, upon such terms and in such manner as it deems appropriate, Goods or Related Services similar to those undelivered or not performed, and the Supplier shall be liable to the Purchaser for any additional costs for such similar Goods or Related Services.

However, the Supplier shall continue performance of the Contract to the extent not terminated.

- 42.4 In the event as stated under GCC Clause 42.1(d), the Purchaser shall,
- (a) terminate the Supplier's employment under the Contract and cancel the contract, after giving 14 days notice to the Supplier and the provisions of Clause 42 shall apply as if such expulsion had been made under Sub-Clause 42.1
 - (b) declare, at its discretion, the concerned Person to be ineligible to participate in further Procurement proceedings, either indefinitely or for a specific period of time.

43. Termination for insolvency

- 43.1 The Purchaser shall terminate this Contract if the Supplier is declared bankrupt or insolvent as determined with finality by a court of competent jurisdiction. In this event, termination will be without compensation to the Supplier, provided that such termination will not prejudice or affect any right of action or remedy which has accrued or will accrue thereafter to the Purchaser and/or the Supplier.

44. Termination for Convenience

- 44.1 The Purchaser, by written notice sent to the supplier, may terminate this Contract, in whole or in part, at any time for its convenience. The notice of termination shall specify that the termination is for the Purchaser's convenience, the extent to which performance of the supplier under the contract is terminated, and the date upon which such termination becomes effective.

- 44.2 Any of the following circumstances may constitute sufficient grounds to terminate a contract for conveniences :

- (a) If Physical and economic conditions have significantly changed so as to render the contract no longer economically, financially or technically feasible, as determined by the Head of Purchaser;
- (b) The Head of Purchaser has determined the existences of conditions that make contract implementation impractical and/or unnecessary, such as, but not limited to , fortuitous event/s, change in laws and government policies;
- (c) Funding for the contract has been withheld or reduced;
- (d) Any circumstances analogous to the foregoing.

- 44.3 The GOODS that have been delivered and/or performed or are ready for delivery or performance within thirty (30) calendar days after the Supplier's receipt of Notice to Terminate shall be accepted by the Purchaser at the contract terms and prices. For GOODS not yet performed and/or ready for delivery, the Purchaser may elect:

- (a) to have any portion delivered and/or performed and paid at the contract terms and prices; and/or
- (b) to cancel the remainder and pay to the Supplier an agreed amount for partially completed and/or performed goods and for materials and parts previously procured by the Supplier.

45. Procedures for Termination of Contracts

- 45.1 The following provisions shall govern the procedures for termination of this Contract as stated under GCC Clauses 42,43 and 44:
- (a) Upon receipt of a written report of acts or causes which may constitute ground(s) for termination as aforementioned, or upon its own initiative, the Purchaser shall, within a period of seven (7) calendar days, verify the existence of such ground(s) and cause the execution of a Verified Report, with all relevant evidence attached;
 - (b) Upon recommendation by the Purchaser, the Head of the Purchaser shall terminate this Contract only by a written notice to the Supplier conveying the termination of this Contract. The notice shall state:
 - i. that this Contract is being terminated for any of the ground(s) afore-mentioned, and a statement of the acts that constitute the ground(s) constituting the same;
 - ii. the extent of termination, whether in whole or in part;
 - iii. an instruction to the Supplier to show cause as to why this Contract should not be terminated; and
 - iv. special instructions of the Purchaser, if any.
 - (c) The Notice to Terminate shall be accompanied by a copy of the Verified Report;
 - (d) Within a period of seven (7) calendar days from receipt of the Notice of Termination, the Supplier shall submit to the Head of the Purchaser a verified position paper stating why this Contract should not be terminated. If the Supplier fails to show cause after the lapse of the seven (7) day period, either by inaction or by default, the Head of the Purchaser shall issue an order terminating this Contract;
 - (e) The Purchaser may, at any time before receipt of the Supplier's verified position paper, withdraw the Notice to Terminate if it is determined that certain items or works subject of the notice had been completed, delivered, or performed before the Supplier's receipt of the notice;
 - (f) Within a non-extendible period of ten (10) calendar days from receipt of the verified position paper, the Head of the Purchaser shall decide whether or not to terminate this Contract. It shall serve a written notice to the Supplier of its decision and, unless otherwise provided, this Contract is deemed terminated from receipt of the Supplier of the notice of decision. The termination shall only be based on the ground(s) stated in the Notice to Terminate; and
 - (g) The Head of the Purchaser may create a Contract Termination Review Committee (CTRC) to assist him in the discharge of this function. All decisions recommended by the CTRC shall be subject to the approval of the Head of the Purchaser.

46. Contract Amendment

- 46.1 Subject to applicable laws, no variation in or modification of the terms of this Contract shall be made except by written amendment signed by the

parties.

- 46.2 The Purchaser, in accordance with their Delegation of Financial Powers, as required, may amend the Contract to reflect the changes introduced to the Original terms and Conditions of the Contract.

47. Settlement of Disputes

47.1 Amicable Settlement:

- (a) The Purchaser and the Supplier shall use their best efforts to settle amicably all disputes arising out of or in connection with this Contract or its interpretation.

47.2 Adjudication

- (a) If the Supplier /Purchaser believe that amicable settlement of dispute is not possible between the two parties, the dispute shall be referred to the Adjudicator within fourteen (14) days of first written correspondence on the matter of disagreement;
- (b) The Adjudicator named in the PCC is jointly appointed by the parties. In case of disagreement between the parties, the Appointing Authority designated in the PCC shall appoint the Adjudicator within fourteen (14) days of receipt of a request from either party;
- (c) The Adjudicator shall give its decision in writing to both parties within twenty-eight (28) days of a dispute being referred to it;
- (d) The supplier shall make all payments (fees and reimbursable expenses) to the Adjudicator, and the Purchaser shall reimburse half of these fees through the regular progress payments;
- (e) Should the Adjudicator resign or die, or should the Purchaser and the Supplier agree that the Adjudicator is not functioning in accordance with the provisions of the Contract; a new Adjudicator will be jointly appointed by the Purchaser and the Supplier. In case of disagreement between the Purchaser and the Supplier the Adjudicator shall be designated by the Appointing Authority designated in the PCC at the request of either party, within fourteen (14) days of receipt of a request from either party.

47.3 Arbitration

- (a) If the Parties are unable to reach a settlement under GCC Clause 47.1(a) within twenty-eight (28) days of the first written correspondence on the matter of disagreement, then either Party may give notice to the other party of its intention to commence arbitration in accordance with GCC Sub-Clause 47.3(b);
- (b) The arbitration shall be conducted in accordance with the rules of procedure specified in the PCC.

Section 4. Particular Conditions of Contract

Instructions for completing the Particular Conditions of Contract are provided, as needed, in the notes in italics mentioned for the relevant GCC clauses.

GCC Clause	Amendments of, and Supplements to, Clauses in the General Conditions of Contract
GCC 1.1(j)	The Purchaser is: Rural Power Company Ltd.
	Representative: Executive Director (Engineering) Rural Power Company Ltd. House-19, Road-1/B, Sector-09, Uttara Model Town, Dhaka-1230, Bangladesh.
	Consignee: Plant In-charge , Mymensingh Power Station, Shambhuganj, Mymensingh, Bangladesh
GCC 1.1(o)	The point of delivery is: Mymensingh Power Station, Shambhuganj, Mymensingh, Bangladesh.
GCC 5.1(i)	The following documents shall also be part of the Contract: I. Acceptance of NOA. II. Performance Security. III. All clarifications regarding this tender.
GCC 11.1	For notices , the Purchaser's contact details shall be: Attention: Executive Director (Engineering) Address: Rural Power Company Ltd. House-19, Road-1/B, Sector-09, Uttara Model Town, Dhaka-1230, Bangladesh Telephone: +88 02 48961201 Facsimile number: +88 02 48963229 Electronic mail address: edengg@rpcl.gov.bd
	For notices , the Supplier's contact details shall be: Attention: Address: Telephone: Facsimile number: Electronic mail address:
GCC 18.1	The scope of Supply: "At the time of awarding the Contract, the Purchaser shall specify any change in the Scope of Supply with respect to Section 6: Schedule of requirement included in the Tender Document. Such changes may be due, for instance, if the quantities of goods and related Services are increased or decreased at time of award".

GCC 22.2	<p>The packing, marking and documentation within and outside the packages shall be:</p> <p>A complete packing list indicating the content of each package shall be enclosed in a water proof envelope and shall be secured to the outside of the packing case. In addition, each packing shall be clearly marked with indelible ink/paint on at least four sides as follows:</p> <ul style="list-style-type: none">a) Name and address of Purchaserb) Name of the Supplierc) Contract Descriptiond) Final Destination/Delivery Pointe) Gross weightf) Net weightg) Package number of total number of packagesh) Brief description of the contenti) Any special lifting instructions (if any)j) Any special handling instructions(if any) <p>Upright markings, where appropriate, shall be placed on all four vertical sides of the package. All materials used for packing shall be environmentally neutral.</p> <p>Additional marking and documentation within and outside the packages shall be: 'Handle with care', Fragile, Keep in Cool and dry place etc., if needed.</p>
-----------------	---

Not For Submission

<p>GCC 23.2</p>	<p>The Purchaser reserves the right to cancel without informing the supplier, any or all items not delivered within the specified delivery period and to purchase the same from any other source at the expense of the supplier.</p> <p>Details of shipping and other documents to be furnished by the Supplier shall be: Upon shipment, the Supplier shall notify the Purchaser and the Insurance Company by telex or fax the full details of the shipment, including Contract number, description of Goods, quantity, the vessel, the Bill of Lading/Airway Bill number and date, port of loading, date of shipment, port of discharge, etc. The Supplier shall send the following documents to the Purchaser, with a copy to the Insurance Company within Seven (7) days of shipment:</p> <ul style="list-style-type: none"> (a) One (1) original and Three (3) copies invoice of the Supplier showing the description of the Goods, quantity, unit price, and total amount; (b) One (1) original and Three (3) copies of the negotiable clean, on-board Bill of lading/ Airway bill marked “freight prepaid”; (c) One (1) Original and Three (3) copies of the packing list identifying contents of each package; (d) One (1) copy of Insurance certificate. (e) One (1) original Manufacturer’s/Supplier’s warranty stating that the offered items are new, unused and of the most recent or current models, and that they incorporate all recent improvements in accordance with GCC 33.1 & will be fitted in the existing system and will operate satisfactorily during the warranty period as stated under GCC 33.3 of PCC; (f) Manufacturer’s factory test certificate for items of the Package-1, Lot-1 & Package-2, Lot-1 and for the items of Package-2, Lot-2 where applicable. (g) Certificate of origin issued/attested by the Chamber of Commerce of Exporting/ Manufacturer’s Country in one (1) original. <p>The Supplier shall ensure that the documents to be sent are free from any discrepancy. In case of any discrepancy in the documents, the supplier shall be responsible for any consequent expenses, such as additional bank charges, additional demurrage at port owing to delayed clearance of Goods etc. The negotiable sets of documents shall be original, signed by the Supplier.</p> <p>The supplier shall also ensure that the Purchaser shall receive the above documents at least Three (03) days before arrival of the Goods at the port or place of arrival and, if not received, the Supplier will be responsible for any consequent expenses. The shipping documents described above shall be supplied as follows-</p> <table border="0" style="width: 100%;"> <tr> <td style="width: 80%;">1. Executive Director (Engineering), RPCL, Dhaka</td> <td style="text-align: right;">1(one) set</td> </tr> <tr> <td>2. Executive Director (Finance & Accounts), RPCL, Dhaka</td> <td style="text-align: right;">1(one) set</td> </tr> <tr> <td>3. Plant In-charge, MPS, Mymensingh</td> <td style="text-align: right;">1(one) set</td> </tr> </table>	1. Executive Director (Engineering), RPCL, Dhaka	1(one) set	2. Executive Director (Finance & Accounts), RPCL, Dhaka	1(one) set	3. Plant In-charge, MPS, Mymensingh	1(one) set
1. Executive Director (Engineering), RPCL, Dhaka	1(one) set						
2. Executive Director (Finance & Accounts), RPCL, Dhaka	1(one) set						
3. Plant In-charge, MPS, Mymensingh	1(one) set						
<p>GCC 25.1</p>	<p>The Contract price is: As specified in Contract Agreement.</p>						
<p>GCC 26.2</p>	<p>The suppliers responsibilities according to Incoterm: 2020 are as follows: Package-1, Lot-1: CPT any Seaport/Landport of Bangladesh. Package-2, Lot-1: CPT Hazrat Shahjalal Int’l Airport, Dhaka. Package-2, Lot-2: CPT Hazrat Shahjalal Int’l Airport, Dhaka.</p> <p>Insurance shall be arranged by RPCL. Hence, the contract price shall not include cost of insurance.</p>						

GCC 27.1	<p>The method and conditions of payment to be made to the Supplier under this Contract shall be as follows:</p> <p>Payments under this contract shall be made in the currency of the Tender for Foreign Currency. Foreign currency payments shall be made in favor of the supplier through irrevocable Letter of credit (LC) opened in favor of the supplier in a scheduled bank of Bangladesh in the following manner:-</p> <ol style="list-style-type: none"> a) On Shipment: Eighty (80) percent Payment of the contract price will be made after shipment of the materials from the supplier/ manufacturers end on presentation of original invoice certified by the purchaser, clean original shipping documents specified in GCC clause 23.2 and other necessary documents (as per LC) to negotiating bank. b) On Acceptance: Twenty (20) percent of the foreign currency payment of Goods received shall be paid upon submission of invoice supported by satisfactory Material Receiving Report (MRR) and Quality Certificate issued by the consignee after Joint Inspection done by both parties. <p>BANKING CHARGES:</p> <ol style="list-style-type: none"> a) Letter of Credit opening and other charges including amendment charges within Bangladesh shall be borne by RPCL and those outside Bangladesh shall be borne by the supplier. b) The supplier shall have to bear all such charges both inside and outside Bangladesh in case of amendment of LC if done at the request of the supplier.
GCC 27.3	Payments shall be made in no case later than the 30 days after submission of an invoice or request for payment by the Supplier, and after the Purchaser has accepted it.
GCC 27.5	Payments shall be made in no case later than the days <i>[Indicate the days]</i> after submission of an invoice or request for payment by the Supplier, and after the Purchaser has accepted it. Not Applicable.
GCC 28.2	<p>Insurance:</p> <p>The goods supplied under the contract shall be fully insured in a freely convertible currency against loss or damage incidental to manufacture or acquisition, transportation, storage and delivery. In this manner all Insurance shall be made by the RPCL through Bangladesh Sadharan Bima Corporation or any other reputed insurance company of Bangladesh with re insured to Bangladesh Sadharan Bima Corporation. The supplier shall inform directly to the Purchaser in the following Way:</p> <p>No sooner had the shipment is effected, as well as the materials reached the port of the destination, the supplier shall inform the purchaser about where, when and how those Imported Equipment/Materials are stored/shall be stored/are going to be stored at the Sea Port/Land Port/Airport.</p> <p>Shipment of Goods in any chartered vessel over 15(fifteen) years of age and shipment of goods in the Deck are prohibited. If the supplier fails to comply with these instructions they shall be held fully responsible for any loss or damage arising out of the non-compliance of these contract conditions.</p>
GCC 32.1	<p>Inspections and Tests</p> <ol style="list-style-type: none"> a) The Purchaser has right to inspect, test and where necessary, reject the Goods after arrival in the purchaser's store shall in no way be limited or waived by reason of the Goods having previously been tested and passed by the manufacturer/ supplier. b) Joint Inspection: Joint inspection shall be carried out with participation of the representative of supplier and RPCL upon arrival of the goods at the departmental store of Mymensingh Power Station, Shambhuganj, Mymensingh.

GCC 32.6	Not Applicable
GCC 33.3	<p>The period of validity of the Warranty shall be:</p> <p>Warranty:</p> <ol style="list-style-type: none"> The period of validity of warranty is Twelve (12) month from date of issuance of Material Receiving Report (MRR) after joint inspection cum receiving in Mymensingh Power Station. The Purchaser shall promptly notify the supplier in writing of any claim arising under this warranty. Upon receipt of such notice, with in Thirty (30) days the supplier shall, with all reasonable speed repairs or replace the defective goods or parts thereof, without cost to the Purchaser including delivery to RPCL'S store complete in all respects. The warranty period for the replaced equipment / parts/ goods of the supply shall be counted from the date of such replacement/ delivery to stores and shall be extended by the supplier by a period of Twelve (12) months and the performance guarantee shall be extended accordingly for those defective Goods. If the supplier, having been notified, fails to remedy the defect (s) within a reasonable period, the purchaser may proceed to take such action/actions as may be necessary, at the supplier's risk and expense and without prejudice to any other rights which the purchaser may have against the supplier under the provisions of the contract. <p>For purpose of the Warranty, the place(s) of final destination(s) shall be: Mymensingh Power Station.</p>
GCC 33.6	The Supplier shall correct any defects covered by the Warranty within 30 days of being notified by the Purchaser of the occurrence of such defects.
GCC 35.1	<p>The applicable rate for liquidated damages for delay shall be: 0.1 % (Zero point One) percent of the Contract Price of the delayed Goods for each day of delay until actual delivery.</p> <p>Supplier is responsible for supplying 100% contracted items. If supplier fails to deliver any item, The Procuring entity will procure the item from other source and actual cost will be adjusted from supplier's payment or the purchaser can adjust LD at the rate of 20% of the cost of non-supplied items.</p>
	The maximum amount of liquidated damages shall be Ten (10%) percent of the Contract Price.
GCC 47.2(b)	<p>The name of the Adjudicator:</p> <p>The President of the Institution of Engineers, Bangladesh (IEB)</p> <p>The name of the appointing authority of the Adjudicator shall be finalized by both the parties if necessary.</p>
GCC 47.3(b)	<p>The rules of procedure for arbitration proceedings shall be as follows:</p> <p>Any dispute, controversy or claim arising out of or relating to this Contract, or breach, termination or invalidity thereof, shall be settled by arbitration in accordance with the Bangladesh Arbitration Act 2001 as at present in force.</p>

Section 5. Tender and Contract Forms

Form	Title
Tender Forms	
PG4 – 1	Tender Submission Letter
PG4 – 2	Tenderer Information Sheet
PG4– 3A,3B & 3C	Price Schedule for Goods
PG4– 3D	Price Schedule for Related Services
PG4 – 4	Specifications Submission and Compliance Sheet
PG4 – 5	Manufacturer’s Authorisation Letter
PG4 – 6	Bank Guarantee for Tender Security
Contract Forms	
PG4 – 7	Notification of Award
PG4 – 8	Contract Agreement
PG4 – 9	Bank Guarantee for Performance Security
PG4 – 10	Bank Guarantee for Advance Payment

Forms PG4-1 to PG4-6 comprises part of the Tender and should be completed as stated in ITT Clause 21.

Forms PG4-7 to PG4-10 comprises part of the Contract as stated in GCC Clause 5.

Tender Submission Letter (Form PG4 – 1)

[This letter shall be completed and signed by the Authorized Signatory preferably on the Letter-Head pad of the Tenderer].

To: [Contact Person] [Name of Purchaser] [Address of Purchaser]	Date:
Invitation for Tender No:	[indicate IFT No]
Tender Package No:	[indicate Package No]
Lot No:	[indicate number of Lots]

We, the undersigned, offer to supply in conformity with the Tender Document the following Goods and related Services:

--

In accordance with ITT Clauses 22 and 23, the following prices and discounts apply to our Tender:

The Tender Price is: *Taka [state amount in figures]*
(ITT Sub-Clause 23.1) *and Taka[state amount in words]*

Mandatory Spare parts Price *Taka [state amount in figures]*
(If economic Factor is applicable) *and Taka[state amount in words]*
(ITT Sub-Clause 52.2 (f)& 52.5 (b))

The unconditional discount for being *Taka [state amount in figures]*
awarded more than one lot in this package *and Taka[state amount in words]*
is:
(ITT Sub-Clause 23.8)

The methodology for Application of the *[state the methodology]*
discount is:
(ITT Sub-Clause 23.9)

The advance payment is: *[state the amount based on percentage*
(GCC Sub-Clause 27.1) *of the Tender Price]*

and we shall accordingly submit an Advance Payment Guarantee in the format shown in Form PG4 - 10.

In signing this letter, and in submitting our Tender, we also confirm that:

- a) our Tender shall be valid for the period stated in the Tender Data Sheet (ITT Sub-Clause 27.2) and it shall remain binding upon us and may be accepted at any time before the expiration of that period;
- b) a Tender Security is attached in the form of a *bank guarantee* in the amount stated in the Tender Data Sheet (ITT Clause 29) and valid for a period of 28 days beyond the Tender validity date;

c) if our Tender is accepted, we commit to furnishing a Performance Security in the amount stated in the Tender Data Sheet (ITT Sub-Clause 63.2) in the form stated in Tender Data Sheet (ITT Sub-Clause 64.1) and valid for a period of 28 days beyond the date of completion of our performance obligations;

d) we have examined and have no reservations to the Tender Document, issued by you on *[insert date]*;

including Addendum to Tender Documents No(s) *[state numbers]* ,issued in accordance with the Instructions to Tenderers (ITT Clause 11). *[insert the number and issuing date of each addendum; or delete this sentence if no Addendum have been issued]*;

e) we, including as applicable, subcontractor for any part of the contract resulting from this Tender process, have nationalities from eligible countries, in accordance with ITT Sub-Clause 5.1;

f) we are submitting this Tender as a sole Tenderer

g) we are not a Government owned entity as defined in ITT Sub-Clause 5.3
or
we are a Government owned entity, and we meet the requirements of ITT Sub-Clause 5.3];
(delete one of the above as appropriate)

h) we, declare that we are not associated, nor have been associated in the past, directly or indirectly, with a consultant or any other entity that has prepared the design, specifications and other documents, in accordance with ITT Sub-Clause 5.5;

i) we, including as applicable subcontractor have not been declared ineligible by the Government of Bangladesh on charges of engaging in corrupt, fraudulent, collusive or coercive practices, in accordance with ITT Sub-Clause 5.6;

j) furthermore, we are aware of ITT Sub Clause 4.3 concerning such practices and pledge not to indulge in such practices in competing for or in executing the Contract;

k) we intend to subcontract an activity or part of the Supply, in accordance with ITT Sub-Clause 16.1 to the following Subcontractor(s);

Nature of the Supply or related service	Name and address of Subcontractor

l) we, confirm that we do not have a record of poor performance, such as abandoning the Supply, not properly completing contracts, inordinate delays, or financial failure as stated in ITT Sub-Clause 5.8, and that we do not have, or have had, any litigation against us, other than that stated in the Tenderer Information Sheet(Form PG4-2);

m) we are not participating as Tenderers in more than one Tender in this Tendering process. We understand that your written Notification of Award shall become a binding Contract between us, until a formal Contract is prepared and executed;

-
- n) we understand that you reserve the right to accept or reject any Tender, to cancel the Tender proceedings, or to reject all Tenders, without incurring any liability to Tenderers, in accordance with ITT Clause 58.1.

Signature:

<i>[insert signature of authorized representative of the Tenderer]</i>
--

Name:

<i>[insert full name of signatory with National ID]</i>

In the capacity of:

<i>[insert designation of signatory]</i>
--

Duly authorized to sign the Tender for and on behalf of the Tenderer

[If there is more than one (1) signatory add other boxes and sign accordingly].

Attachment 1: Written confirmation authorizing the above signatory(ies) to commit the Tenderer, in accordance with ITT Sub-Clause 34.3;

Not For Submission

	<ul style="list-style-type: none"> □ A certificate issued by the competent authority of Bangladesh stating that the Tenderer is a Tax payer having valid Tax identification Number (TIN) and VAT registration number or in lieu any other document acceptable to the Purchaser demonstrating that the Tenderer is a genuine Tax payer and has a VAT registration number as a proof of fulfilment of taxation obligations in accordance with ITT Clause 5 . □ Documentary evidence demonstrating that they are enrolled in the relevant professional or trade organizations registered in Bangladesh in accordance with ITT Clause 5.
<p>2. Litigation History: [Number of arbitration awards against the tenderer over the period in accordance the ITT Clause 13.1] if no [state “None”]</p>	
<p>3. Qualification Information of the Tenderer:</p>	
3.1	<p>Number of years of overall experience of the Tenderer in the supply of goods and related services as stated under ITT Sub-Clause 14.1(a):</p>
3.2	<p>Number of completed supply contracts in the supply of similar goods and related services of required value within the period mentioned in TDS as stated under ITT Sub-Clause 14.1(b):</p> <ul style="list-style-type: none"> ▪ Number of Contracts: ▪ Value of the Contracts: ▪ Period of the Contract:
3.3	<p>The supply and/or production capacity of Goods, if applicable, as stated under ITT Sub-Clause 14.(c)</p>
3.4	<p>Available liquid assets or working capital or credit facility in accordance with ITT Clause 15.1(a)</p>

Price Schedule for Goods (Form PG4-3A)

[Group A Tenders: Goods Manufactured in Bangladesh]

Invitation for Tender No:		Date:	
Tender Package No:		Package Description:	<i>[enter description as specified in Section 6]</i>
Tender Lot No:		Lot Description:	<i>[enter description as specified in Section 6]</i>

1	2	3	4	5	6	7	8	9	10	
Line Item No .	Description of Item	Unit of Measurement	Quantity	Unit price EXW <i>[FC or Taka.]</i>	EXW price per Line Item <i>(Col. 4 × 5) [FC or Taka.]</i>	Inland transportation, Insurance and other local costs for the delivery of the Goods to their final destination <i>[Taka]</i>	Cost of local labour, raw materials and components from with origin in Bangladesh	VAT Payable on account of Supplier if the Contract is awarded <i>[Taka]</i>	Total Price per line item <i>(Col. 6+7)</i>	
									FC	Taka
<i>[Insert number of the item]</i>	<i>[Insert name of Goods]</i>	<i>[Insert name of the Unit]</i>	<i>[Insert number of Unit to be supplied]</i>	<i>[Insert EXW unit price, also indicate Currency]</i>	<i>[Insert total EXW price per line item]</i>	<i>[Insert corresponding price per line item]</i>	<i>[Insert cost of local labour, raw material and components as a % of the Col 5]</i>	<i>[Insert Supplier's VAT if Contract is awarded]</i>	<i>[Insert total price per line item]</i>	
1										
Note : Price offered in foreign currency (FC) & Bangladesh Taka							Total Price for Lot			
Point of Delivery as per Schedule of Requirement:						Period of Delivery as per Schedule of Requirement:				

Name:	<i>[insert full name of signatory]</i>	<i>Signature with Date and Seal</i>
In the capacity of:	<i>[insert designation of signatory]</i>	<i>[Sign]</i>
Duly authorized to sign the Tender for and on behalf of the Tenderer		

Price Schedule for Goods (Form PG4-3B)
[Group B Tenders: Goods Manufactured outside Bangladesh, to be imported]

Invitation for Tender No:	PUR- 008(FG/MPS/OTM)/2020-2021	Date:	24/09/2020
Tender Package No:	01	Package Description:	Procurement of Air Filters of GT and Generator for Mymensingh Power Station.
Tender Lot No:	01	Lot Description:	Procurement of Air Filters of GT and Generator for Mymensingh Power Station.

1	2	3	4	5	6	7
Line Item No.	Description of Item	Country of Origin	Unit of Measurement	Quantity	Unit price CPT any Seaport/Landport of Bangladesh [USD/ Euro]	Total Price per line item [USD/Euro](Col. 5*Col. 6)
<i>[Insert number of the item]</i>	<i>[Insert name of Goods]</i>	<i>[insert country of origin of the Good]</i>	<i>[Insert name of the Unit]</i>	<i>[Insert number of Unit to be supplied]</i>	<i>[Insert unit price in CPT, also indicate currency]</i>	<i>[Insert total price per line item]</i>
1.	GT Air Intake Filter (cylindrical)		Pcs	1404		
2.	GT Air Intake Filter (conical)		Pcs	1404		
3.	Generator Air Filter (Cylindrical)		Pcs	512		

Note : Price offered in USD/Euro	Total Price for Lot
Point of Delivery as per Schedule of Requirement: Any Seaport/Landport of Bangladesh	Period of Delivery as per Schedule of Requirement: 90 days from the date of opening Letter of Credit.

Name:	<i>[insert full name of signatory]</i>	Signature with Date and Seal
In the capacity of:	<i>[insert designation of signatory]</i>	<i>[Sign]</i>
Duly authorized to sign the Tender for and on behalf of the Tenderer		

Price Schedule for Goods (Form PG4-3B)
[Group B Tenders: Goods Manufactured outside Bangladesh, to be imported]

Invitation for Tender No:	PUR- 008(FG/MPS/OTM)/2020-2021	Date:	24/09/2020
Tender Package No:	02	Package Description:	Procurement of Bearings and Hardware for Mymensingh Power Station.
Tender Lot No:	01	Lot Description:	Procurement of GT Bearings for Mymensingh Power Station.

1	2	3	4	5	6	7
Line Item No.	Description of Item	Country of Origin	Unit of Measurement	Quantity	Unit price CPT Hazrat Shahjalal International Airport, Dhaka [USD/ Euro]	Total Price per line item [USD/Euro](Col. 5*Col. 6)
<i>[Insert number of the item]</i>	<i>[Insert name of Goods]</i>	<i>[insert country of origin of the Good]</i>	<i>[Insert name of the Unit]</i>	<i>[Insert number of Unit to be supplied]</i>	<i>[Insert unit price in CPT, also indicate currency]</i>	<i>[Insert total price per line item]</i>
1.	Half Bearing		Pcs	2		
2.	Half Bearing		Pcs	2		
3.	Bearing		Pcs	2		
4.	Thrust Bearing		Pcs	1		
5.	Thrust Bearing		Pcs	1		
6.	Half Bearing		Pcs	2		
7.	Half Bearing		Pcs	2		
8.	Bearing		Pcs	2		
9.	Bearing		Pcs	2		
10.	Oil Deflector		Pcs	1		

11.	Oil Deflector		Pcs	1		
12.	Bearing No.1		Set	1		
13.	Bearing No.2		Set	1		
14.	Bearing No.3		Set	1		
15.	Bearing No.4		Set	1		
16.	Bearing No.5		Set	1		
Note : Price offered in USD/Euro			Total Price for Lot			
Point of Delivery as per Schedule of Requirement: Hazrat Shahjalal International Airport, Dhaka				Period of Delivery as per Schedule of Requirement: 90 days from the date of opening Letter of Credit.		

Name:	<i>[insert full name of signatory]</i>	Signature with Date and Seal
In the capacity of:	<i>[insert designation of signatory]</i>	<i>[Sign]</i>
Duly authorized to sign the Tender for and on behalf of the Tenderer		

Price Schedule for Goods (Form PG4-3B)
[Group B Tenders: Goods Manufactured outside Bangladesh, to be imported]

Invitation for Tender No:	PUR- 008(FG/MPS/OTM)/2020-2021	Date:	24/09/2020
Tender Package No:	02	Package Description:	Procurement of Bearings and Hardware for Mymensingh Power Station.
Tender Lot No:	02	Lot Description:	Procurement of GT Hardware for Mymensingh Power Station.

1	2	3	4	5	6	7
Line Item No.	Description of Item	Country of Origin	Unit of Measurement	Quantity	Unit price CPT Hazrat Shahjalal International Airport, Dhaka [USD/ Euro]	Total Price per line item [USD/Euro](Col. 5*Col. 6)
<i>[Insert number of the item]</i>	<i>[Insert name of Goods]</i>	<i>[insert country of origin of the Good]</i>	<i>[Insert name of the Unit]</i>	<i>[Insert number of Unit to be supplied]</i>	<i>[Insert unit price in CPT, also indicate currency]</i>	<i>[Insert total price per line item]</i>
1.	Hexa Head Bolt, UNC		Pcs	4		
2.	Insulation Tape		Pcs	2		
3.	Connector, Thermocouple		Pcs	3		
4.	Connector		Pcs	2		
5.	Connector		Pcs	2		
6.	Ring		Pcs	1		
7.	Gasket		Pcs	100		
8.	Insulation Package/Cover		Pcs	2		
9.	Insulation Package/Cover		Pcs	6		

10.	Key, 1 st Stage Shroud		Pcs	34		
11.	Pin, 1 st Stage Shroud		Pcs	18		
12.	Plug 1/4-18NPT		Pcs	30		
13.	Key		Pcs	33		
14.	Stud, Body Bound		Pcs	2		
15.	Twelve Point Bolt,		Pcs	5		
16.	Stud, Body Bound		Pcs	1		
17.	Hex. Head Bolt		Pcs	4		
18.	Hex. Head Bolt,		Pcs	14		
19.	Gasket		Pcs	2		
20.	Hex. Head Bolt		Pcs	32		
21.	Locking Plate		Pcs	4		
22.	Spacer/Distance Pipe		Pcs	10		
23.	Hex. Head Bolt		Pcs	14		
24.	Support diffuser		Pcs	7		
25.	Locking Plate		Pcs	16		
26.	Hex. Head Bolt		Pcs	12		
27.	Twelve Point Bolt		Pcs	2		
28.	Stud		Pcs	4		
29.	Socket Head Cap Screw		Pcs	1		
30.	Dowel Pin		Pcs	1		
31.	Dowel Pin		Pcs	1		
32.	Spring		Pcs	32		

33.	Bushing		Pcs	128		
34.	Bushing		Pcs	128		
35.	Washer		Pcs	64		
36.	Tube Connector		Pcs	2		
37.	Anti-Seize Compound		Pcs	5		
38.	Lock Wire		Pcs	2		
39.	Nut		Pcs	4		
40.	Pin		Pcs	12		
41.	Shim Upper Ring/ Fill Washer		Pcs	2		
42.	Hex. Head Bolt		Pcs	30		
43.	Hex. Head Bolt, UNC		Pcs	10		
44.	Locking Pin		Pcs	1		
45.	Hex. Head Bolt		Pcs	56		
46.	Expansion Joint Segm. Fwd		Pcs	14		
47.	Gasket, (1Set=4Pcs)		Set	2		
48.	Compound Sealing		Pcs	5		
49.	Hexagon Nut, 1/2 13F INOX		Pcs	30		
50.	Hex. Head Bolt, UNC 1/2-13UNCX57mm		Pcs	28		
51.	Generator Diode		Pcs	5		
52.	Ring Seal/Oil Seal Ring		Pcs	2		
53.	Oil Seal Ring		Pcs	1		
54.	Bearing Seal 1 /Oil Seal Ring		Pcs	1		

55.	Oil Seal Ring, Deflector		Pcs	1		
56.	Oil Seal Ring, Stationary		Pcs	2		
Note : Price offered in USD/Euro		Total Price for Lot				
Point of Delivery as per Schedule of Requirement: Hazrat Shahjalal International Airport, Dhaka				Period of Delivery as per Schedule of Requirement: 150 days from the date of opening Letter of Credit.		

Name:	<i>[insert full name of signatory]</i>	Signature with Date and Seal
In the capacity of:	<i>[insert designation of signatory]</i>	<i>[Sign]</i>
Duly authorized to sign the Tender for and on behalf of the Tenderer		

Not For Submission

Price Schedule for Goods (Form PG4-3C)

[Group B Tenders: Goods Manufactured outside Bangladesh, already imported]

Invitation for Tender No:		Date:	
Tender Package No:		Package Description:	<i>[enter description as specified in Section 6]</i>
Tender Lot No:		Lot Description:	<i>[enter description as specified in Section 6]</i>

1	2	3	3	4	5	6	7	8	9	10	11
Line Item No .	Description of Item	Country of Origin	Unit of Measurement	Quantity	Unit price Including Custom Duties, import VAT & other import taxes already paid <i>[Taka]</i>	Custom Duties, import VAT & other import taxes already paid per unit <i>[Taka]</i>	Unit Price per line item net of Custom Duties, import VAT & other import taxes already paid <i>[Taka]</i> (Col. 5 – Col.6)	Price per line item net of Custom Duties, import VAT & other import taxes already paid <i>[Taka]</i> (Col.4X Col. 7)	Inland transportation, Insurance and other local costs for the delivery of the Goods to their final destination <i>[Taka]</i>	VAT Payable on account of Supplier if the Contract is awarded <i>[Taka]</i>	Total Price per line item (Col.8+ Col.9) <i>[Taka]</i>
<i>[Insert number of the item]</i>	<i>[Insert name of Goods]</i>	<i>[insert country of origin of the Good]</i>	<i>[Insert name of the Unit]</i>	<i>[Insert number of Unit to be supplied]</i>	<i>[Insert unit price including CD & all import taxes]</i>	<i>[Insert CD, VAT & import taxes paid per unit] to be supported by documents</i>	<i>[insert unit price net of CD, VAT and import taxes]</i>	<i>[insert price per line item net of CD, VAT and import taxes]</i>	<i>[Insert corresponding price per line item]</i>	<i>[Insert Supplier's VAT if Contract is awarded]</i>	<i>[Insert total price per line item]</i>
Note : Price offered in Bangladesh Taka							Total Price for Lot				
Point of Delivery as per Schedule of Requirement:							Period of Delivery as per Schedule of Requirement:				

Name:	<i>[insert full name of signatory]</i>	<i>Signature with Date and Seal</i>
In the capacity of:	<i>[insert designation of signatory]</i>	<i>[Sign]</i>
Duly authorized to sign the Tender for and on behalf of the Tenderer		

Price and Completion Schedule - Related Services (Form PG4-3D) (NA)

Invitation for Tender No:		Date:	
Tender Package No:		Package Description:	<i>[enter description as specified in Section 6]</i>
Tender Lot No:		Lot Description:	<i>[enter description as specified in Section 6]</i>

1	2	3	4	5	6	7	8	9	
Service No.	Description of Services (excludes inland transportation and other services required in Bangladesh to convey the goods to their final destination)	Country of Origin	Unit of Measurement	Quantity	Unit price of service <i>[FC] or [Taka]</i>	Price per line item of service (Col. 5 X Col. 6) <i>[FC] or [Taka]</i>	VAT Payable on account of Supplier if the Contract is awarded <i>[Taka]</i>	Total Price per line item of service (Col. 7)	
								FC	Taka
<i>[insert number]</i>	<i>[insert name of Services]</i>	<i>[insert country of origin of the Service]</i>	<i>[Insert name of the Unit]</i>	<i>[Insert number of Unit to be supplied]</i>	<i>[Insert unit price]</i>	<i>[Insert price per line item of service]</i>	<i>[Insert Supplier's VAT if Contract is awarded]</i>	<i>[Insert total price per line item of service]</i>	
<i>Note Price offered in foreign currency (FC) & Bangladesh Taka</i>						Total Price for Lot			
Point of Delivery as per Schedule of Requirement:					Period of Delivery as per Schedule of Requirement:				

Name:	<i>[insert full name of signatory]</i>	<i>Signature with Date and Seal</i>
In the capacity of:	<i>[insert designation of signatory]</i>	<i>[Sign]</i>
Duly authorized to sign the Tender for and on behalf of the Tenderer		

Specifications Submission and Compliance Sheet (Form PG4-4)

Invitation for Tender No:	PUR- 008(FG/MPS/OTM)/2020-2021	Date:	24/09/2020
Tender Package No:	01	Package Description:	Procurement of Air Filters of GT and Generator for Mymensingh Power Station.
Tender Lot No:	01	Lot Description:	Procurement of Air Filters of GT and Generator for Mymensingh Power Station.

Item No.	Description of Items	Country of Origin	Make and Model (When applicable)	Full Technical Specification and Standards
1	2	3	4	5

[The Tenderer should add columns and complete all the columns as required]

Signature:

<i>[insert signature of authorized representative of the Tenderer]</i>
--

Name:

<i>[insert full name of signatory]</i>
--

In the capacity of:

<i>[insert designation of signatory]</i>
--

Duly authorized to sign the Tender for and on behalf of the Tenderer

Specifications Submission and Compliance Sheet (Form PG4-4)

Invitation for Tender No:	PUR- 008(FG/MPS/OTM)/2020-2021	Date:	24/09/2020
Tender Package No:	02	Package Description:	Procurement of Bearings and Hardware for Mymensingh Power Station.
Tender Lot No:	01	Lot Description:	Procurement of GT Bearings for Mymensingh Power Station.

Item No.	Description of Items	Country of Origin	Make and Model (When applicable)	Full Technical Specification and Standards
1	2	3	4	5

[The Tenderer should add columns and complete all the columns as required]

Signature:

<i>[insert signature of authorized representative of the Tenderer]</i>
--

Name:

<i>[insert full name of signatory]</i>
--

In the capacity of:

<i>[insert designation of signatory]</i>
--

Duly authorized to sign the Tender for and on behalf of the Tenderer

Specifications Submission and Compliance Sheet (Form PG4-4)

Invitation for Tender No:	PUR- 008(FG/MPS/OTM)/2020-2021	Date:	24/09/2020
Tender Package No:	02	Package Description:	Procurement of Bearings and Hardware for Mymensingh Power Station.
Tender Lot No:	02	Lot Description:	Procurement of GT Hardware for Mymensingh Power Station.

Item No.	Description of Items	Country of Origin	Make and Model (When applicable)	Full Technical Specification and Standards
1	2	3	4	5

[The Tenderer should add columns and complete all the columns as required]

Signature:

<i>[insert signature of authorized representative of the Tenderer]</i>
--

Name:

<i>[insert full name of signatory]</i>
--

In the capacity of:

<i>[insert designation of signatory]</i>
--

Duly authorized to sign the Tender for and on behalf of the Tenderer

Manufacturer's Authorisation Letter (Form PG4 - 5)

[The Tenderer shall require the Manufacturer to fill in this Form in accordance with the instructions indicated. This letter of authorization should be on the letterhead of the Manufacturer and should be signed by a person with the proper authority to sign documents that are binding on the Manufacturer. The Tenderer shall include it in its tender, if so indicated in the TDS as stated under ITT Sub-Clause 26.1 (b)]

Invitation for Tender No:	Date:
Tender Package No:	
Tender Lot No:	
To: Name and address of Purchaser]	

WHEREAS

We *[insert complete name of Manufacturer]*,

who are official manufacturers of *[insert type of goods manufactured]*, having factories at *[insert full address of Manufacturer's factories]*, do hereby

authorize *[insert complete name of Tenderer]* to supply the following Goods, manufactured by us *[insert name and or brief description of the Goods]*.

We hereby extend our full guarantee and warranty as stated under GCC Clause 33 of the General Conditions of Contract, with respect to the Goods offered by the above Tenderer.

Signed: *[insert signature(s) of authorized representative(s) of the Manufacturer]*

Name: *[insert complete name(s) of authorized representative(s) of the Manufacturer]*

Address: *[insert full address including Fax and e-mail]*

Title: *[insert title]*

Date: *[insert date of signing]*

Bank Guarantee for Tender Security (Form PG4 – 6)

[this is the format for the Tender Security to be issued by a scheduled bank of Bangladesh as stated under ITT Clauses 29 and 30]

Invitation for Tender No:

Date:

Tender Package No:

Tender Lot No:

To:

[Name and address of Purchaser]

TENDER GUARANTEE No:

We have been informed that *[insert name of Tenderer]* (hereinafter called “the Tenderer”) intends to submit to you its Tender dated *[insert date of Tender]* (hereinafter called “the Tender”) for the supply of *[description of goods and related services]* under the above Invitation for Tenders (hereinafter called “the IFT”).

Furthermore, we understand that, according to your conditions, Tenders must be supported by a Bank Guarantee for Tender Security.

At the request of the Tenderer, we *[insert name of bank]* hereby irrevocably undertake to pay you, without cavil or argument, any sum or sums not exceeding in total an amount of Tk *[insert amount in figures and in words]* upon receipt by us of your first written demand accompanied by a written statement that the Tenderer is in breach of its obligation(s) under the Tender conditions, because the Tenderer:

- a. has withdrawn its Tender after opening of Tenders but within the validity of the Tender Security ; or
- b. refused to accept the Notification of Award (NOA) within the period as stated under Instructions to Tenderers (ITT) ; or
- c. failed to furnish Performance Security within the period as stipulated in the NOA; or
- d. refused to sign the Contract Agreement by the time specified in the NOA; or
- e. did not accept the correction of the Tender price following the correction of the arithmetic errors in accordance with the ITT; or

This guarantee will expire:

- (a) if the Tenderer is the successful Tenderer, upon our receipt of a copies of the contract signed by the Tenderer and the Performance Security issued to you in accordance with the ITT; or
- (b) if the Tenderer is not the successful Tenderer, twenty eight (28) days after the expiration of the Tenderer’s Tender validity period, being *[date of expiration of the Tender validity plus twenty eight(28) days]*

Consequently, we must receive at the above-mentioned office any demand for payment under this guarantee on or before that date.

Signature

Seal

Notification of Award (Form PG4 - 7)

Contract No:
To:

Date:

[Name of Contractor]

This is to notify you that your Tender dated *[insert date]* for the supply of Goods and related Services for *[name of contract]* for the Contract Price of Tk *[state amount in figures and in words]* as corrected and modified in accordance with the Instructions to Tenderers, has been approved by *[name of Purchaser]*.

You are thus requested to take following actions:

- i. accept in writing the Notification of Award within seven (7) working days of its issuance pursuant to ITT Sub-Clause 62.3
- ii. furnish a Performance Security in the specified format and in the amount of Tk *[state amount in figures and words]*, within Twenty-eight (28) days from issue of this Notification of Award but not later than *(specify date)*, in accordance with ITT Clause 64.2
- iii. sign the Contract within twenty eight (28) days of issuance of this Notification of Award but not later than *(specify date)*, in accordance with ITT Clause 67.2

You may proceed with the execution of the supply of Goods and related Services only upon completion of the above tasks. You may also please note that this Notification of Award shall constitute the formation of this Contract, which shall become binding upon you.

We attach the draft Contract and all other documents for your perusal and signature.

Signed

Duly authorized to sign for and on behalf of
[name of Purchaser]

Date:

Contract Agreement (Form PG4 - 8)

THIS AGREEMENT made the [day] day of [month][year] between [name and address of Purchaser] (hereinafter called “the Purchaser”) of the one part and [name and address of Supplier] (hereinafter called “the Supplier”) of the other part:

WHEREAS the Purchaser invited Tenders for certain goods and related services, viz, [brief description of goods and related services] and has accepted a Tender by the Supplier for the supply of those goods and related services in the sum of Taka [Contract Price in figures and in words] (hereinafter called “the Contract Price”).

NOW THIS AGREEMENT WITNESSETH AS FOLLOWS:

1. In this Agreement words and expressions shall have the same meanings as are respectively assigned to them in the General Conditions of Contract hereafter referred to.
2. The following documents forming the Contract shall be in the following order of precedence, namely :
 - (a) the signed Form of Contract Agreement;
 - (b) the Notification of Award
 - (c) The Tender and the appendices to the Tender
 - (d) Particular Conditions of Contract;
 - (e) General Conditions of Contract;
 - (f) Technical Specifications;
 - (g) Drawings;
 - (h) Price Schedules and Schedule of Requirements and;
 - (i) other document including correspondences listed in the PCC forming part of the Contract
3. In consideration of the payments to be made by the Purchaser to the Supplier as hereinafter mentioned, the Supplier hereby covenants with the Purchaser to provide the goods and related services and to remedy any defects therein in conformity in all respects with the provisions of the Contract.
4. The Purchaser hereby covenants to pay the Supplier in consideration of the provision of the goods and related services and the remedying of defects therein, the Contract Price or such other sum as may become payable under the provisions of the Contract at the times and in the manner prescribed by the Contract.

IN WITNESS whereof the parties hereto have caused this Agreement to be executed in accordance with the laws of Bangladesh on the day, month and year first written above.

For the Purchaser:

For the Supplier:

Signature

Print Name

Title

In the presence of

Name

Address

Bank Guarantee for Performance Security (Form PG4 – 9)

[This is the format for the Performance Security to be issued by an internationally reputable bank and it shall have correspondent bank located in Bangladesh, to make it enforceable in accordance with ITT Sub-Clause 64.1 pursuant to Rule 27(4) of the Public Procurement Rules, 2008.]

Contract No:

Date:

To:

[Name and address of Purchaser]

PERFORMANCE GUARANTEE No: *[insert Performance Guarantee number]*

We have been informed that *[name of supplier]* (hereinafter called “the Supplier”) has undertaken, pursuant to Contract No *[reference number of Contract]* dated *[date of Contract]* (hereinafter called “the Contract”) for the supply of *[description of goods and related services]* under the Contract.

Furthermore, we understand that, according to your conditions, Contracts must be supported by a performance guarantee.

At the request of the Supplier, we *[name of bank]* hereby irrevocably undertake to pay you, without cavil or argument, any sum or sums not exceeding in total an amount of Tk *[insert amount in figures and in words]* upon receipt by us of your first written demand accompanied by a written statement that the Supplier is in breach of its obligation(s) under the Contract conditions, without you needing to prove or show grounds or reasons for your demand of the sum specified therein.

This guarantee is valid until *[date of validity of guarantee]*, consequently, we must receive at the above-mentioned office any demand for payment under this guarantee on or before that date.

[Signatures of authorized representatives of the bank]

Signature

Seal

Bank Guarantee for Advance Payment (Form PG4 – 10)

[this is the format for the Advance Payment Security to be issued by an internationally reputable bank and it shall have correspondent bank located in Bangladesh, to make it enforceable in accordance with GCC Clause 27.1]

Contract No:

Date:

To:

[Name and address of Purchaser]

ADVANCE PAYMENT GUARANTEE No:

We have been informed that *[name of supplier]* (hereinafter called “the Supplier”) has undertaken, pursuant to Contract No *[reference number of Contract]* dated *[date of Contract]* (hereinafter called “the Contract”) for the supply of *[description of goods and related services]* under the Contract.

Furthermore, we understand that, according to your Particular Conditions of Contract Clause 26.1, Advance Payment(s) on Contracts must be supported by a bank guarantee.

At the request of the Supplier, we *[name of bank]* hereby irrevocably undertake to pay you, without cavil or argument, any sum or sums not exceeding in total an amount of Tk *[insert amount in figures and in words]* upon receipt by us of your first written demand accompanied by a written statement that the Supplier is in breach of its obligation(s) under the Contract conditions, without you needing to prove or show grounds or reasons for your demand of the sum specified therein.

We further agree that no change, addition or other modification of the terms of the Contract to be performed, or of any of the Contract documents which may be made between the Purchaser and the Supplier, shall in any way release us from any liability under this guarantee, and we hereby waive notice of any such change, addition or modification.

This guarantee is valid until *[date of validity of guarantee]*, consequently, we must receive at the above-mentioned office any demand for payment under this guarantee on or before that date.

[Signatures of authorized representatives of the bank]

Signature

Seal

Section 6. Schedule of Requirements

i. List of Goods and Delivery Schedule

When completing Form PG4-3A, 3B & 3C the Tenderer shall quote prices and contract delivery dates for each lot separately, as specified in the List of Goods and Delivery Schedule.

Invitation for Tender No:	PUR- 008(FG/MPS/OTM)/2020-2021	Date:	24/09/2020		
Tender Package No:	01	Package Description:	Procurement of Air Filters of GT and Generator for Mymensingh Power Station.		
Tender Lot No:	01	Lot Description:	Procurement of Air Filters of GT and Generator for Mymensingh Power Station.		
Item No	Description of Items	unit	Quantity	Point of Delivery [Final project site] Destination as specified in TDS	Delivery Date required (in days)
1	2	3	4	5	6
1.	GT Air Intake Filter (cylindrical)	Pcs	1404	Any Seaport/Landport of Bangladesh.	90 days on board from the date of opening letter of credit
2.	GT Air Intake Filter (conical)	Pcs	1404		
3.	Generator Air Filter (Cylindrical)	Pcs	512		
<p>“No credit will be given for earlier completion. Tender offering late contract performance schedules within acceptable period will be accepted but the tenders shall be Adjusted in the evaluation by adding to the Tender Price at the rate of Zero point One (0.10%) Percent of the Tender Price for each day of delay. Tender offering delivery schedules beyond sixty (60) days of the date specified in Section 6, Schedule of Requirement, shall be rejected.”</p>					

Name and Designation of Signatory_____

Signature_____

Date_____

Section 6. Schedule of Requirements

i. List of Goods and Delivery Schedule

When completing Form PG4-3A, 3B & 3C the Tenderer shall quote prices and contract delivery dates for each lot separately, as specified in the List of Goods and Delivery Schedule.

Invitation for Tender No:	PUR- 008(FG/MPS/OTM)/2020-2021		Date:	24/09/2020	
Tender Package No:	02		Package Description:	Procurement of Bearings and Hardware for Mymensingh Power Station.	
Tender Lot No:	01		Lot Description:	Procurement of GT Bearings for Mymensingh Power Station.	
Item No	Description of Items	unit	Quantity	Point of Delivery [Final project site] Destination as specified in TDS	Delivery Date required (in days)
1	2	3	4	5	6
1.	Half Bearing	Pcs	2	Hazrat Shahjalal International Airport, Dhaka	90 days on board from the date of opening letter of credit
2.	Half Bearing	Pcs	2		
3.	Bearing	Pcs	2		
4.	Thrust Bearing	Pcs	1		
5.	Thrust Bearing	Pcs	1		
6.	Half Bearing	Pcs	2		
7.	Half Bearing	Pcs	2		
8.	Bearing	Pcs	2		
9.	Bearing	Pcs	2		
10.	Oil Deflector	Pcs	1		
11.	Oil Deflector	Pcs	1		

12.	Bearing No.1	Set	1		
13.	Bearing No.2	Set	1		
14.	Bearing No.3	Set	1		
15.	Bearing No.4	Set	1		
16.	Bearing No.5	Set	1		
<p>“No credit will be given for earlier completion. Tender offering late contract performance schedules within acceptable period will be accepted but the tenders shall be Adjusted in the evaluation by adding to the Tender Price at the rate of Zero point One (0.10%) Percent of the Tender Price for each day of delay. Tender offering delivery schedules beyond sixty (60) days of the date specified in Section 6, Schedule of Requirement, shall be rejected.”</p>					

Name and Designation of Signatory_____

Signature_____

Date_____

Not For Submission

Section 6. Schedule of Requirements

i. List of Goods and Delivery Schedule

When completing Form PG4-3A, 3B & 3C the Tenderer shall quote prices and contract delivery dates for each lot separately, as specified in the List of Goods and Delivery Schedule.

Invitation for Tender No:	PUR- 008(FG/MPS/OTM)/2020-2021	Date:	24/09/2020		
Tender Package No:	02	Package Description:	Procurement of Bearings and Hardware for Mymensingh Power Station.		
Tender Lot No:	02	Lot Description:	Procurement of GT Hardware for Mymensingh Power Station.		
Item No	Description of Items	unit	Quantity	Point of Delivery [Final project site] Destination as specified in TDS	Delivery Date required (in days)
1	2	3	4	5	6
1.	Hexa Head Bolt, UNC	Pcs	4	Hazrat Shahjalal International Airport, Dhaka	150 days on board from the date of opening letter of credit
2.	Insulation Tape	Pcs	2		
3.	Connector, Thermocouple	Pcs	3		
4.	Connector	Pcs	2		
5.	Connector	Pcs	2		
6.	Ring	Pcs	1		
7.	Gasket	Pcs	100		
8.	Insulation Package/Cover	Pcs	2		

9.	Insulation Package/Cover	Pcs	6		
10.	Key, 1 st Stage Shroud	Pcs	34		
11.	Pin, 1 st Stage Shroud	Pcs	18		
12.	Plug 1/4-18NPT	Pcs	30		
13.	Key	Pcs	33		
14.	Stud, Body Bound	Pcs	2		
15.	Twelve Point Bolt,	Pcs	5		
16.	Stud, Body Bound	Pcs	1		
17.	Hex. Head Bolt	Pcs	4		
18.	Hex. Head Bolt,	Pcs	14		
19.	Gasket	Pcs	2		
20.	Hex. Head Bolt	Pcs	32		
21.	Locking Plate	Pcs	4		
22.	Spacer/Distance Pipe	Pcs	10		
23.	Hex. Head Bolt	Pcs	14		
24.	Support diffuser	Pcs	7		
25.	Locking Plate	Pcs	16		
26.	Hex. Head Bolt	Pcs	12		
27.	Twelve Point Bolt	Pcs	2		
28.	Stud	Pcs	4		
29.	Socket Head Cap Screw	Pcs	1		
30.	Dowel Pin	Pcs	1		
31.	Dowel Pin	Pcs	1		
32.	Spring	Pcs	32		

33.	Bushing	Pcs	128		
34.	Bushing	Pcs	128		
35.	Washer	Pcs	64		
36.	Tube Connector	Pcs	2		
37.	Anti-Seize Compound	Pcs	5		
38.	Lock Wire	Pcs	2		
39.	Nut	Pcs	4		
40.	Pin	Pcs	12		
41.	Shim Upper Ring/ Fill Washer	Pcs	2		
42.	Hex. Head Bolt	Pcs	30		
43.	Hex. Head Bolt, UNC	Pcs	10		
44.	Locking Pin	Pcs	1		
45.	Hex. Head Bolt	Pcs	56		
46.	Expansion Joint Segm. Fwd	Pcs	14		
47.	Gasket, (1Set=4Pcs)	Set	2		
48.	Compound Sealing	Pcs	5		
49.	Hexagon Nut, 1/2 13F INOX	Pcs	30		
50.	Hex. Head Bolt, UNC 1/2- 13UNCX57mm	Pcs	28		
51.	Generator Diode	Pcs	5		
52.	Ring Seal/Oil Seal Ring	Pcs	2		
53.	Oil Seal Ring	Pcs	1		

54.	Bearing Seal 1 /Oil Seal Ring	Pcs	1		
55.	Oil Seal Ring, Deflector	Pcs	1		
56.	Oil Seal Ring, Stationary	Pcs	2		

“No credit will be given for earlier completion. Tender offering late contract performance schedules within acceptable period will be accepted but the tenders shall be Adjusted in the evaluation by adding to the Tender Price at the rate of Zero point One (0.10%) Percent of the Tender Price for each day of delay. Tender offering delivery schedules beyond **sixty** (60) days of the date specified in Section 6, Schedule of Requirement, shall be rejected.”

Name and Designation of Signatory_____

Signature_____

Date_____

Not For Submission

B. List of Related Services and Completion Schedule (N/A)

When completing Form PG4-3D, the Tenderer shall quote prices and Completion date for services for each item against each lot

Item No.	Description of Item	Unit of Measurement	Quantity	Place where Services shall be performed	Final Completion Date(s) of Services
1	2	3	4	5	6
					<i>[insert required Completion Date(s)]</i>
Lot No 1: [enter description]					
<i>[add as many rows and details as there are individual items in the Lot]</i>					
Lot No 2: [enter description]					
<i>[add as many rows and details as there are individual items in the Lot]</i>					

Notes on Related Services

The Purchaser shall clearly specify the related services/Incidental services, other than inland transportation and other services required to convey the Goods to their final destination, in this Schedule of requirement. In particular, these services may refer to any of the following but not limited to:

- (a) performance or supervision of on-site assembly and/or start-up of the supplied Goods;
- (b) performance or supervision or maintenance and/or repair of the supplied Goods, for a period of time as specified, provided that this service shall not relieve the Supplier of any warranty obligations under this Contract; and
- (c) training of the Purchaser's personnel, at the Supplier's plant and/or on-site, in assembly, start-up, operation, maintenance, and/or repair of the supplied Goods

Section 7. Technical Specifications

The Goods and Related Services shall comply with following Technical Specifications:

Invitation for Tender No:	PUR- 008(FG/MPS/OTM)/2020-2021	Date:	24/09/2020
Tender Package No:	01	Package Description:	Procurement of Air Filters of GT and Generator for Mymensingh Power Station.
Tender Lot No:	01	Lot Description:	Procurement of Air Filters of GT and Generator for Mymensingh Power Station.

Item no	Description of Items	Full Technical Specification and Standards			
1	2	3			
1	GT Air Intake Filter (cylindrical)	Type	Single stage pulse type self-cleaning Air Intake Filter.		
		Filter media	Synthetic type with wire net of inner and outer frame		
		Design Flow Data(Rated air flow per filter)	650 CFM per filter		
		Element specification in accordance to different test standard	ASHRAE 52.2:2007 standard Efficiency for 0.3μ m particle : Min. 75% Initial pressure drop : Max. 200Pa Final Pressure drop : 1000 Pa MERV class : 14 Average arrestance (ASHRAE dust): >99% Dust holding capacity : >1700g		
			EN 779:2012 standard Efficiency for 0.4 μm particle :Min. 90% Initial pressure drop : Max. 200 Pa Final Pressure drop : 1000 Pa Filter class : F8 Dust holding capacity (ACF/1000 Pa): >1700g		
		Burst strength	25 Inch W.G.		
		Pulse cleaning system data			
		Cleaning	Cleaning Cycle start : 5.5 mbar Cleaning cycle stop : 4.5 mbar Pulse Interval : 35 sec pulse Length : 0.1 sec Cleaning cycle length: 15 min		
		Compressed Air	Pressure : 7 bar Max temperature : 80deg C		

		Flow	: 1 m ³ /min (free air delivery)	
		Dimension of Air Intake Filter		
		Length	660mm	
		Inner diameter	212 mm	
		Outer diameter	324 mm	
		Number of pleat	300 or ≥ 280	
		Depth of pleat	50 mm±1mm	
		Surface area	> 225 sq ft	
		End cap	Outer Dia: 324 mm and Inner Dia: 212 mm	
		End cap material	Galvanized Steel	
		Filters have to be run under the following environmental condition		
		Location	Rural Area	
		Ambient Temperature	5 ⁰ C---45 ⁰ C	
		Humidity	60%-----99%	
2	GT Air Intake Filter (conical)	Type	Single stage pulse type self-cleaning Air Intake Filter.	
		Filter media	Synthetic type with wire net of inner and outer frame	
		Design Flow Data(Rated air flow per filter)	850 CFM per filter	
		Element specification in accordance to different test standard	ASHRAE 52.2:2007 standard Efficiency for 0.3μ m particle : Min. 75% Initial pressure drop : Max. 200 Pa Final Pressure drop : 1000 Pa MERV class : 14 Average arrestance (ASHRAE dust) : >99% Dust holding capacity : >1900g	
			EN 779:2012 standard Efficiency for 0.4 μm particle :Min. 90% Initial pressure drop : Max. 200 Pa Final Pressure drop : 1000 Pa Filter class : F8 Dust holding capacity (ACF/1000 Pa): >1900g	
		Burst strength	25 Inch W.G.	
		Pulse cleaning system data		
		Cleaning	Cleaning Cycle start : 5.5 mbar Cleaning cycle stop : 4.5 mbar Pulse Interval : 35 sec pulse Length : 0.1 sec Cleaning cycle length : 15 min	
			Compressed Air	Pressure : 7 bar

			Max temperature : 80deg C Flow : 1 m ³ /min (free air delivery)
		Dimension of Air Intake Filter	
		Length	660 mm
		Inner diameter	Upper: 212 mm and Lower: 330 mm
		Outer diameter	Upper: 324 mm and Lower: 445 mm
		Number of pleat	350 or ≥ 320
		Depth of pleat	50mm±1mm
		Surface area	> 250 sq ft
		End cap	Larger: Outer Dia:445 mm & Inner dia:330 mm Smaller: Outer dia:324 mm & Inner dia:212 mm
		End cap material	Galvanized Steel
		Filters have to be run under the following environmental condition	
		Location	Rural Area
		Ambient Temperature	5 ⁰ C---45 ⁰ C
		Humidity	60%-----99%
3.	Generator Air Filter (Cylindrical Filter)	Type	Single stage pulse type self-cleaning Air Intake Filter.
		Filter media	Synthetic Fiber type with wire net of inner and outer frame
		Design Flow Data (Rated air flow per filter)	650 CFM per filter
		Element specification in accordance to different test standard	ASHRAE 52.2:2007 standard Efficiency for 0.3μ m particle : Min. 75% Initial pressure drop : Max. 200Pa Final Pressure drop : 1000 Pa MERV class : 14 Average arrestance (ASHRAE dust) : >99% Dust holding capacity : >1700g Eurovent Class : EU8
			EN 779:2012 standard Efficiency for 0.4 μm particle :Min. 90% Initial pressure drop : Max. 200 Pa Final Pressure drop : 1000 Pa Filter class : F8 Dust holding capacity (ACF/1000 Pa) : >1700g
		Burst strength	25 Inch W.G.
		Pulse cleaning system data	
		Cleaning	Initial airflow resistance : 1.8 mbar Cleaning Cycle start : 4 mbar (40 mm H ₂ O) Cleaning cycle stop : 3 mbar (30 mm H ₂ O) Pulse Interval : 45 sec pulse Length : 0.10 sec

		Cleaning cycle length	: 12 min
	Compressed Air	Pressure	: 7 bar
		Max temperature	: 80 deg C
		Flow	: 0.14 m ³ /min (free air delivery)
	Dimension of Air Intake Filter		
	Length	660 mm	
	Inner diameter	212 mm	
	Outer diameter	324 mm	
	Number of pleat	300 or \geq 280	
	Depth of pleat	50 mm \pm 1 mm	
	Surface area	> 225 sq ft	
	End cap	Outer Dia: 324 mm and Inner Dia: 212 mm	
	End cap material	Galvanized Steel	
	Filters have to be run under the following environmental condition		
	Location	Rural Area	
	Ambient Temperature	5 ⁰ C to 45 ⁰ C	
	Humidity	60% to 99%	
	End cap material	Galvanized Steel	

Not For Submission

Section 7. Technical Specifications

The Goods and Related Services shall comply with following Technical Specifications:

Invitation for Tender No:	PUR- 008(FG/MPS/OTM)/2020-2021	Date:	24/09/2020
Tender Package No:	02	Package Description:	Procurement of Bearings and Hardware for Mymensingh Power Station.
Tender Lot No:	01	Lot Description:	Procurement of GT Bearings for Mymensingh Power Station.

Item no	Description of Items	Full Technical Specification and Standards		
1	2	3		
1.	Half Bearing	Part No: 75A048C1	Accessory Gearbox (FLENDER - GRAFFENSTADEN B.P 84F - 67402 ILLKIRCHCEDEX, FRANCE, Ref. No: ALSTOM 91402566P022, Type: BA51BA, N - 6007, Year of Built: 1998, Capacity / Energy: 250 KW, Gear Ratio: 5100 / 3582.6/ 1445, Total Weight : 2100 Kg, Type of Oil : ISO VG 32, Flow of Oil : 60 L/min, Pressure : 1.7 Bar.)	
2.	Half Bearing	Part No: 75A049C1		
3.	Bearing	Part No: 75A002E3		
4.	Thrust Bearing	Part No: 75A097D3		
5.	Thrust Bearing	Part No: 75A098D3		
6.	Half Bearing	Part No: 75A073E1/ C1		
7.	Half Bearing	Part No: 75A074C1		
8.	Bearing	Part No: 75A003G3		
9.	Bearing	Part No: 75A004G3		
10.	Oil Deflector	Part No: 73C270A2		
11.	Oil Deflector	Part No: 73C402A2		
12.	Bearing No.1	Part No: 05C630E3		Load Gearbox (FLENDER - GRAFFENSTADEN, Ref. No. 53/L39700/C44, Type: TRL65CV, N - 5972, Year Of built: 1998, Capacity / Energy: 54000 KW, Gear Ratio: 5163/3000, Service factor: 1.3, Standard: AGMA421-06, Total Weight: 12000 Kg, Type of Oil: ISO VG 32, Flow of Oil: 750 L/min, Pressure: 1.4 -1.75 Bar, Construction: API 613 - 88, Number of teeth wheel/pinion: 74/43)
13.	Bearing No.2	Part No: 05D282G3		
14.	Bearing No.3	Part No: 05D283H3		
15.	Bearing No.4	Part No: 05D309H3		
16.	Bearing No.5	Part No: 05D309H3		

Section 7. Technical Specifications

The Goods and Related Services shall comply with following Technical Specifications:

Invitation for Tender No:	PUR- 008(FG/MPS/OTM)/2020-2021	Date:	24/09/2020
Tender Package No:	02	Package Description:	Procurement of Bearings and Hardware for Mymensingh Power Station.
Tender Lot No:	02	Lot Description:	Procurement of GT Hardware for Mymensingh Power Station.

Item no	Description of Items	Full Technical Specification and Standards
1	2	3
1.	Hexa Head Bolt, UNC	GE Part No: N14BP25012
2.	Insulation Tape	GE Part No: 226A2066P001
3.	Connector, Thermocouple	GE Part No: 287A1399P019
4.	Connector	GE Part No: 156A1085P014
5.	Connector	GE Part No: 156A1085P018
6.	Ring	GE Part No: N38423
7.	Gasket	GE Part No: 302A4594P203
8.	Insulation Package/Cover	GE Part No: 188C9473G001
9.	Insulation Package/Cover	GE Part No: 188C9473G002
10.	Key, 1 st Stage Shroud	GE Part No: 279A1660P001
11.	Pin, 1 st Stage Shroud	GE Part No: 227C9033P001
12.	Plug 1/4-18NPT	GE Part No: 286A6290P002
13.	Key	GE Part No: 213B1362P001
14.	Stud, Body Bound	GE Part No: 158A4647P008
15.	Twelve Point Bolt,	GE Part No: N733AP50192
16.	Stud, Body Bound	GE Part No: 158A4647P002
17.	Hex. Head Bolt	GE Part No: N22P25016
18.	Hex. Head Bolt,	GE Part No: 293A0911P016
19.	Gasket	GE Part No: 351A9259P015
20.	Hex. Head Bolt	GE Part No: N24P25012
21.	Locking Plate	GE Part No: 279A1652P001
22.	Spacer/Distance Pipe	GE Part No: 307A9887P002
23.	Hex. Head Bolt	GE Part No: 293A0914P012
24.	Support diffuser	GE Part No: 356A1754P001
25.	Locking Plate	GE Part No: 261A7644P005

26.	Hex. Head Bolt	GE Part No: N14P21014
27.	Twelve Point Bolt	GE Part No: N733AP44080
28.	Stud	GE Part No: 156A1591P014
29.	Socket Head Cap Screw	GE Part No: N170P29048
30.	Dowel Pin	GE Part No: 158A5457P058
31.	Dowel Pin	GE Part No: 158A5457P022
32.	Spring	GE Part No: 158A7887P001
33.	Bushing	GE Part No: 158A7888P002
34.	Bushing	GE Part No: 339A9913P001
35.	Washer	GE Part No: 352A6633P003
36.	Tube Connector	GE Part No: 156A1075P010
37.	Anti-Seize Compound	GE Part No: 287A1397P001
38.	Lock Wire	GE Part No: 279A1710P001
39.	Nut	GE Part No: N245P00025
40.	Pin	GE Part No: 213B1457P001
41.	Shim Upper Ring/ Fill Washer	GE Part No: 213B1460P002
42.	Hex. Head Bolt	GE Part No: N60AP29080
43.	Hex. Head Bolt, UNC	GE Part No: N14P25020
44.	Locking Pin	GE Part No: 279A1622P001
45.	Hex. Head Bolt	GE Part No: N14P29028
46.	Expansion Joint Segm. Fwd	GE Part No: 279A2644P001
47.	Gasket, (1Set=4Pcs)	GE Part No: 279A2645P001
48.	Compound Sealing	GE Part No: A15B041G4
49.	Hexagon Nut, 1/2 13F INOX	GE Part No: N201P00029
50.	Hex. Head Bolt, UNC 1/2-13UNCX57mm	GE Part No: N14P29036
51.	Generator Diode	Set of Diodes, Diode 309/UA/160/S675A, Alstom Ref: 26783C00
52.	Ring Seal/Oil Seal Ring	GE Part No: 188C9738G001
53.	Oil Seal Ring	GE Part No: 154D7145G001
54.	Bearing Seal 1 /Oil Seal Ring	GE Part No: 164C2807G003
55.	Oil Seal Ring, Deflector	GE Part No: 164C2819P001
56.	Oil Seal Ring, Stationary	GE Part No: 177D9782G001

Notes on Technical Specifications

[The Purchaser shall follow the Rule 29 of Public Procurement Rule, 2008 while preparing the Technical Specifications of the Goods]

[A set of precise and clear specifications is a prerequisite for Tenders to respond realistically and competitively to the requirements of the Purchaser. In the context of Competitive Tender, the specifications must be prepared to permit the widest possible competition and, at the same time, present a clear statement of the required standards of workmanship, materials, and performance of the goods and services to be procured. Only if this is done will the objectives of transparency, equity, efficiency, fairness and economy in procurement be realized, responsiveness of Tenders be ensured, and the subsequent task of Tender evaluation and post-qualification facilitated. The specifications should require that all items, materials and accessories to be included or incorporated in the goods be new, unused, and of the most recent or current models, and that they include or incorporate all recent improvements in design and materials]

Not For Submission

Section 8. Drawings

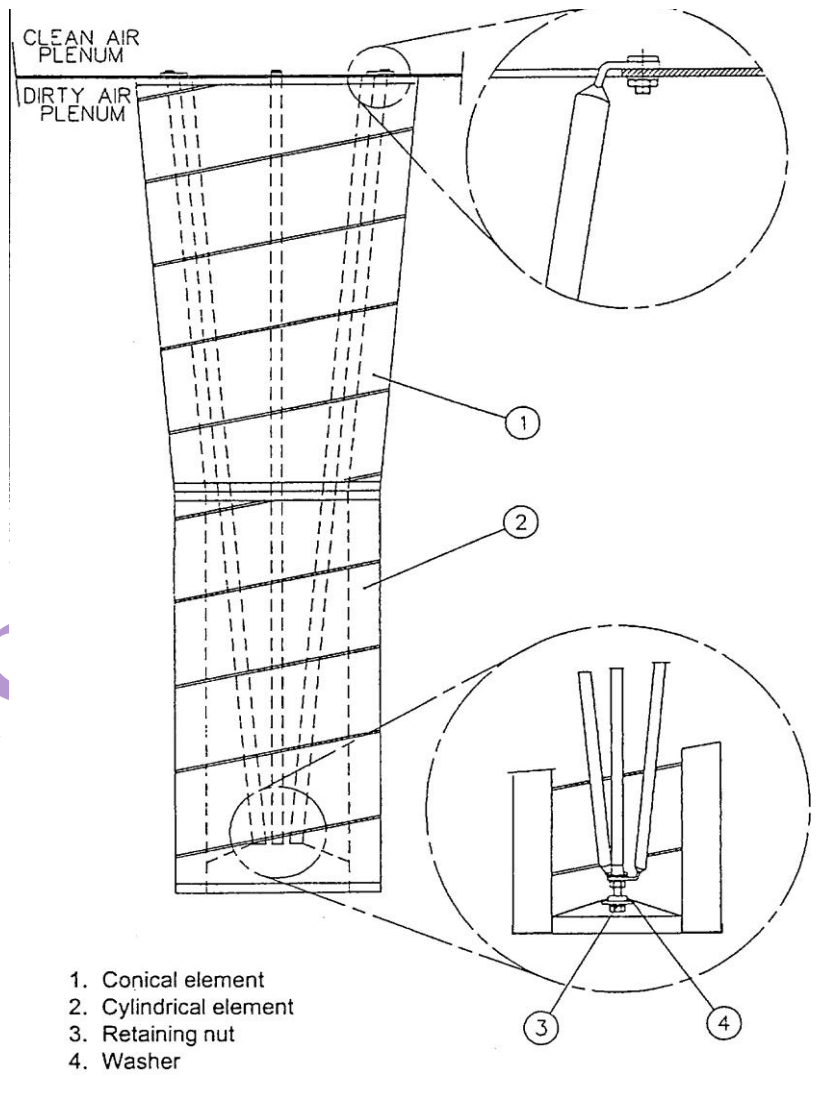
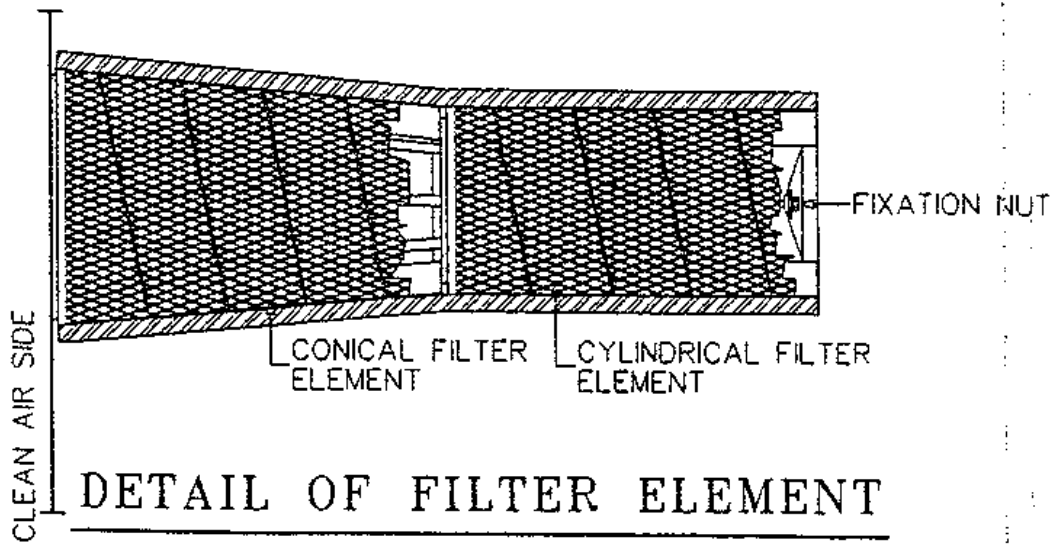

Fig: GT Intake Air Filter element and fixation picture.

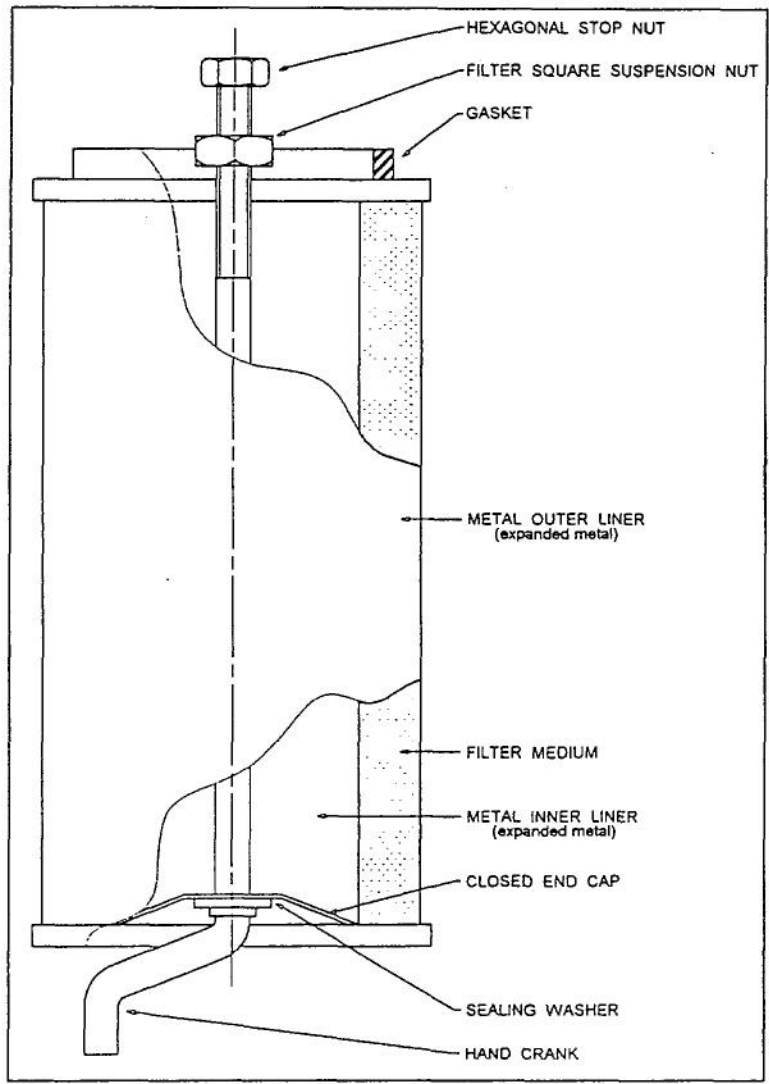

Fig: Generator Air Filter (Cylindrical) Drawing.



Fig: Existing Generator Diode Image.

Features

- Wide current range
- High voltage ratings up to 2500V
- High surge current capabilities
- Stud cathode and stud anode version
- High resistance to acceleration

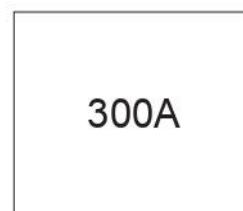

Typical Applications

- Converters
- Power supplies
- Machine tool controls
- High power drives
- Medium traction applications

Major Ratings and Characteristics

Parameters	301U(R)		Units
	160 to 200	250	
$I_{F(AV)}$	330	300	A
@ T_C	120	120	°C
$I_{F(RMS)}$	520	470	A
I_{FSM} @ 50Hz	8250	6050	A
@ 60Hz	8640	6335	A
I^2t @ 50Hz	340	183	KA ² s
@ 60Hz	311	167	KA ² s
V_{RRM} range	1600 to 2000	2500	V
T_J	- 40 to 180	- 40 to 180	°C

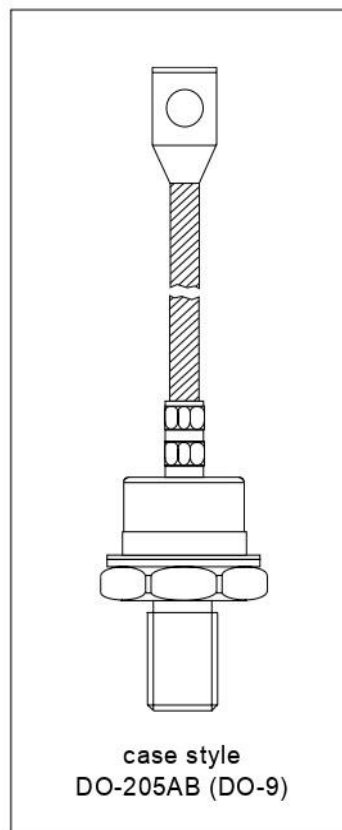

301U(R) Series

Bulletin I2032 rev. B 03/03

International
 Rectifier

ELECTRICAL SPECIFICATIONS

Voltage Ratings

Type number	Voltage Code	V_{RRM} , maximum repetitive peak reverse voltage V	V_{RSM} , maximum non-repetitive peak rev. voltage V	I_{RRM} max. @ $T_J = T_J$ max. mA
301U(R)	160	1600	1700	15
	200	2000	2100	
	250	2500	2600	

Forward Conduction

Parameter	301U(R)		Units	Conditions
	160to200	250		
$I_{F(AV)}$ Max. average forward current @ Case temperature	330 120	300 120	A °C	180° conduction, half sine wave
$I_{F(RMS)}$ Max. RMS forward current	520	470	A	DC @ $T_C = 115^\circ\text{C}$ (up to 2000V), $T_C = 102^\circ\text{C}$ (2500V)
I_{FSM} Max. peak, one-cycle forward, non-repetitive surge current	8250	6050	A	t = 10ms No voltage reappplied
	8640	6335		t = 8.3ms
	6940	5090		t = 10ms 100% V_{RRM} reappplied
	7270	5330		t = 8.3ms
I^2t Maximum I^2t for fusing	340	183	KA ² s	t = 10ms No voltage reappplied
	311	167		t = 8.3ms
	241	129		t = 10ms 100% V_{RRM} reappplied
	220	118		t = 8.3ms
$I^2\sqrt{t}$ Maximum $I^2\sqrt{t}$ for fusing	3400	1830	KA ² √s	t = 0.1 to 10ms, no voltage reappplied
$V_{F(TO)1}$ Low level value of threshold voltage	0.77	0.90	V	$(16.7\% \times I_{F(AV)} < I < I_{F(AV)}), T_J = T_J$ max.
$V_{F(TO)2}$ High level value of threshold voltage	0.84	0.97		$(I > I_{F(AV)}), T_J = T_J$ max.
r_{f1} Low level value of forward slope resistance	0.49	0.59	mΩ	$(16.7\% \times I_{F(AV)} < I < I_{F(AV)}), T_J = T_J$ max.
r_{f2} High level value of forward slope resistance	0.49	0.55		$(I > I_{F(AV)}), T_J = T_J$ max.
V_{FM} Max. forward voltage drop	1.22	1.46	V	$I_{pk} = 942\text{A}, T_J = T_J$ max, $t_p = 10\text{ms}$ sinusoidal wave

Thermal and Mechanical Specifications

Parameter	301U(R)	Units	Conditions
T _J Max. junction operating temperature range	-40 to 180	°C	
T _{stg} Max. storage temperature range	-40 to 200		
R _{thJC} Max. thermal resistance, junction to case	0.14	K/W	DC operation
R _{thCS} Max. thermal resistance, case to heatsink	0.08		Mounting surface, smooth, flat and greased
T Max. allowed mounting torque +0 -20%	37	Nm	Not lubricated threads
	28		Lubricated threads
wt Weight	301U	g	
	303U		
	305U		
	307U		
	309U		
Case style	DO-205AB (DO-9)		See Outline Table

ΔR_{thJC} Conduction

(The following table shows the increment of thermal resistance R_{thJC} when devices operate at different conduction angles than DC)

Conduction angle	Sinusoidal conduction		Rectangular conduction		Units	Conditions
	80 to 200	250	00 to 200	250		
180°	0.015	0.015	0.011	0.011	K/W	T _J = T _J max.
120°	0.018	0.018	0.019	0.019		
90°	0.023	0.023	0.025	0.025		
60°	0.034	0.034	0.035	0.035		
30°	0.056	0.056	0.057	0.057		

Ordering Information Table

Device Code

30	1	U	A	250
①	②	③	④	⑤

- 1** - 30 = Essential Part Number
- 2** - 1 = Standard Device
 - 3 = Top Threaded version
 - 5 = Type for rotating application with Top Threaded version 3/8 16UNC-2A
 - 7 = Type for rotating application with flexible lead
 - 9 = Type for rotating application with Top Threaded version 3/8 24UNF
- 3** - U = Stud Normal Polarity (Cathode to Stud)
 UR = Stud Reverse Polarity (Anode to Stud)
- 4** - A = Max. Leakage selection I_{RRM} = 2mA T_J = 25°C
- 5** - Voltage code: Code x 10 = V_{RRM} (See Voltage Ratings table)

301U(R) Series

Bulletin I2032 rev. B 03/03

International
IOR Rectifier

Outline Table

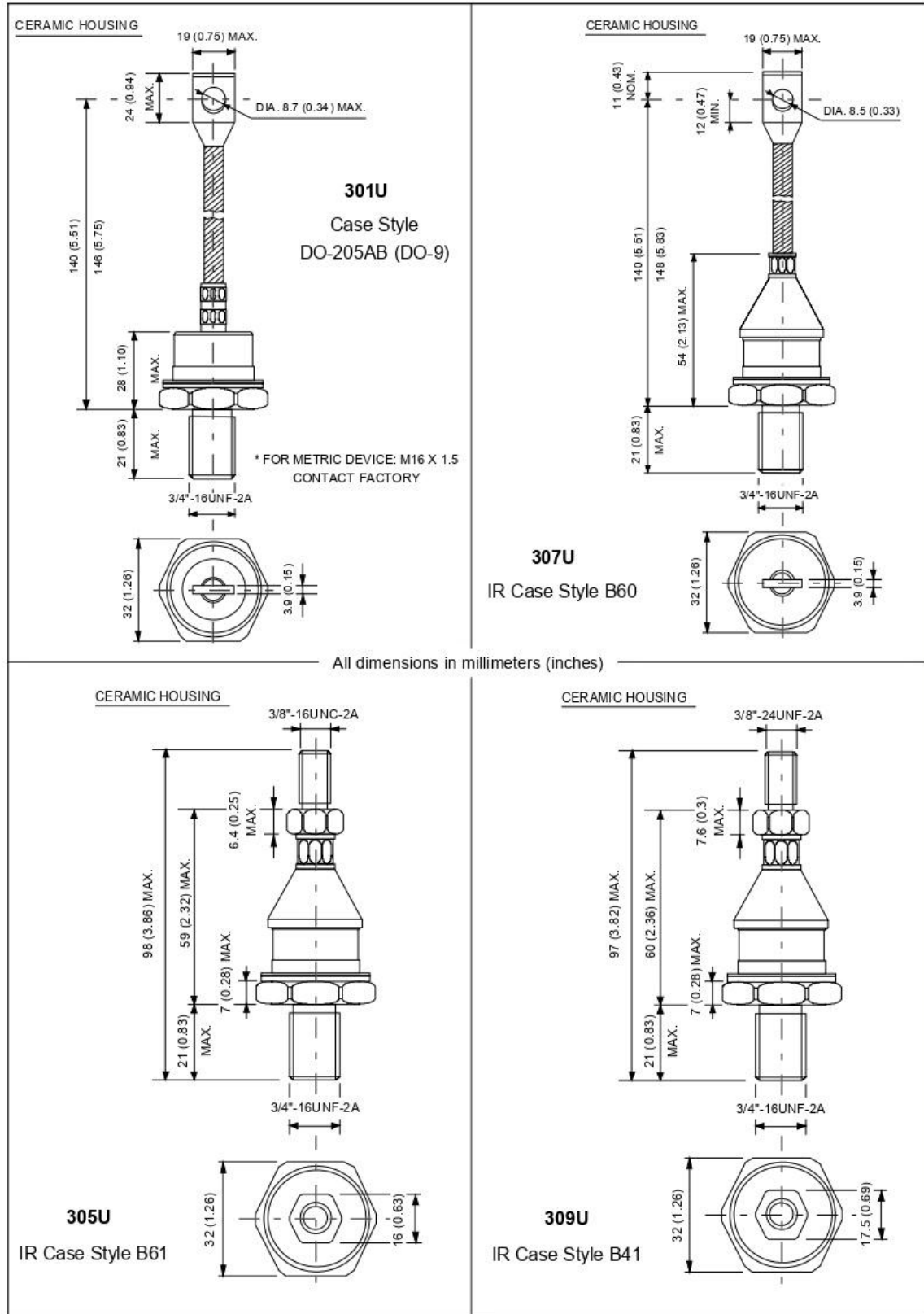

Outline Table

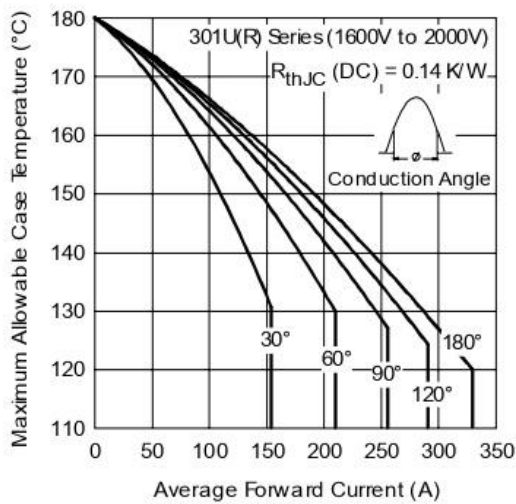
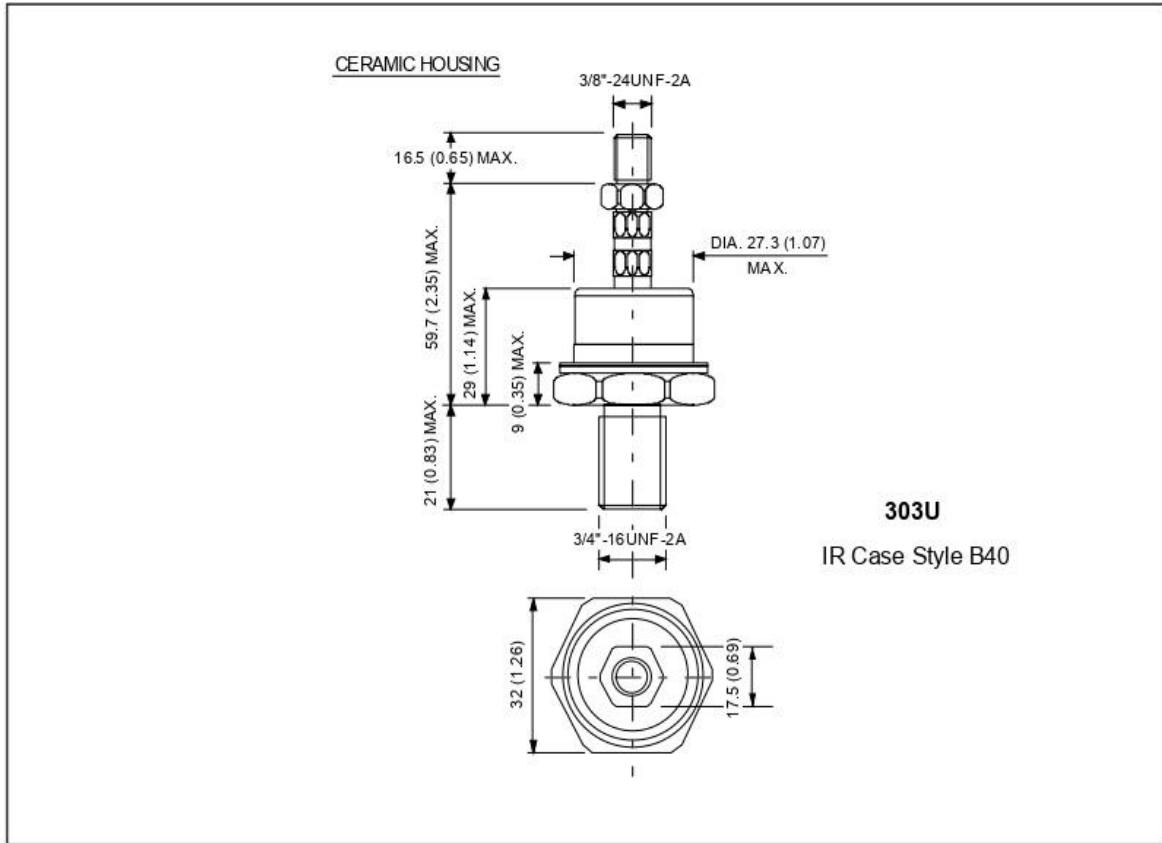

Fig. 1 - Current Ratings Characteristics

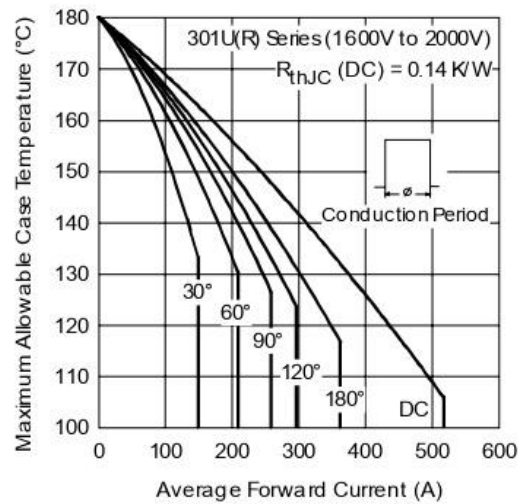

Fig.2 - Current Ratings Characteristics

301U(R) Series

Bulletin I2032 rev. B 03/03

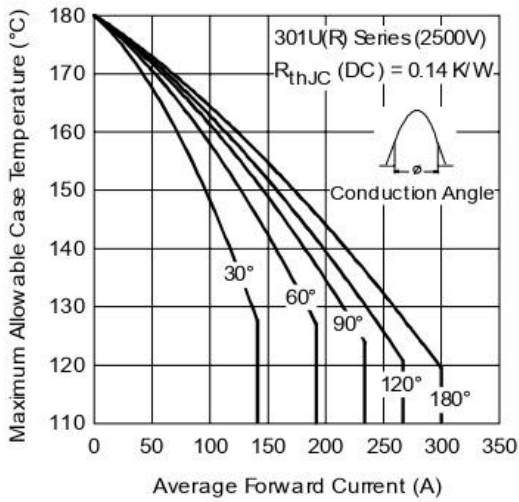

Fig. 3 - Current Ratings Characteristics

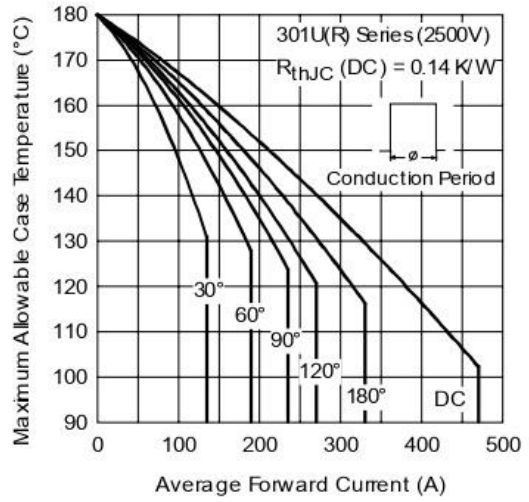

Fig. 4 - Current Ratings Characteristics

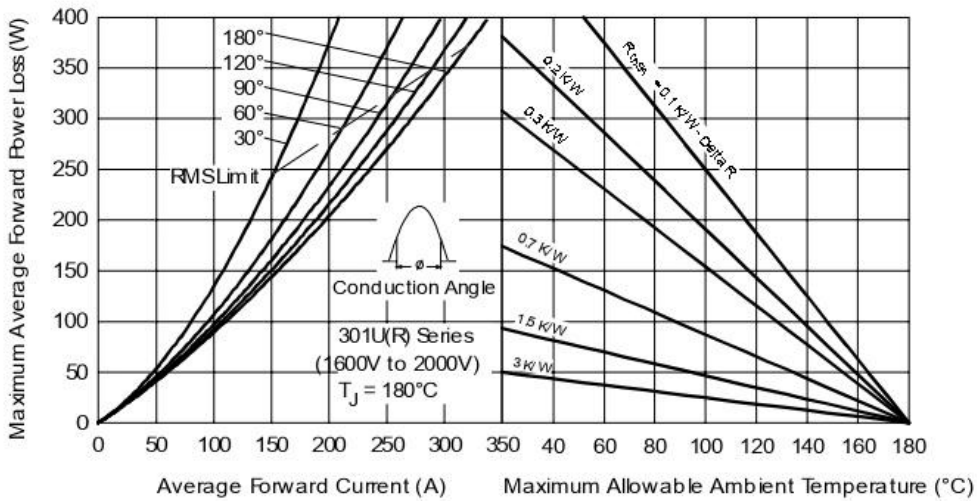

Fig. 5 - Forward Power Loss Characteristics

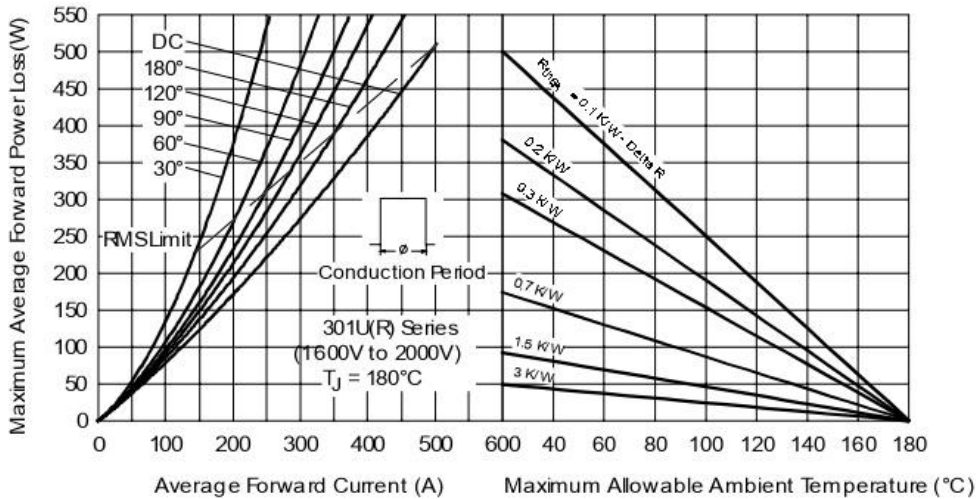

Fig. 6 - Forward Power Loss Characteristics

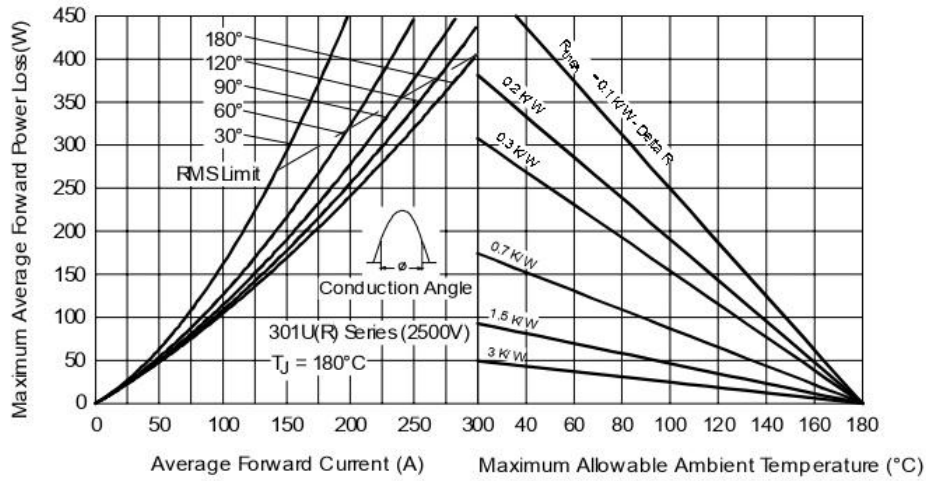

Fig. 7 - Forward Power Loss Characteristics

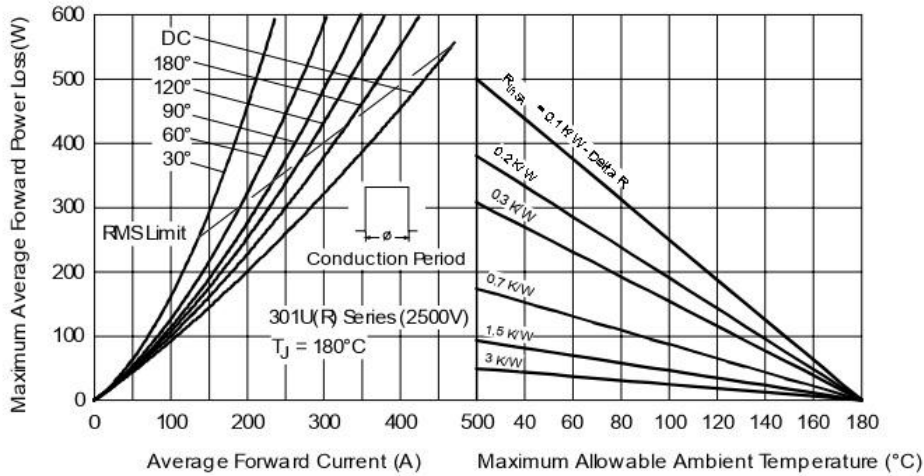

Fig. 8 - Forward Power Loss Characteristics

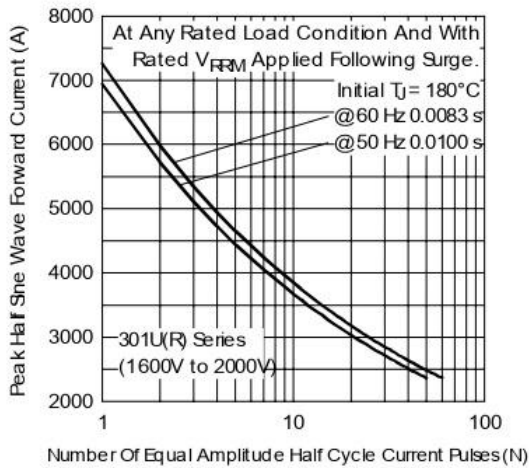

Fig. 9 - Maximum Non-Replicative Surge Current

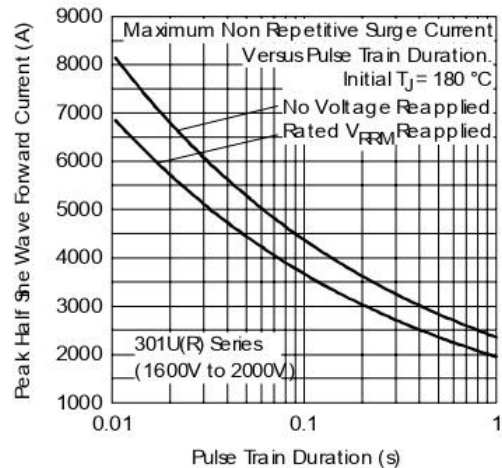

Fig. 10 - Maximum Non-Replicative Surge Current

301U(R) Series

Bulletin I2032 rev. B 03/03

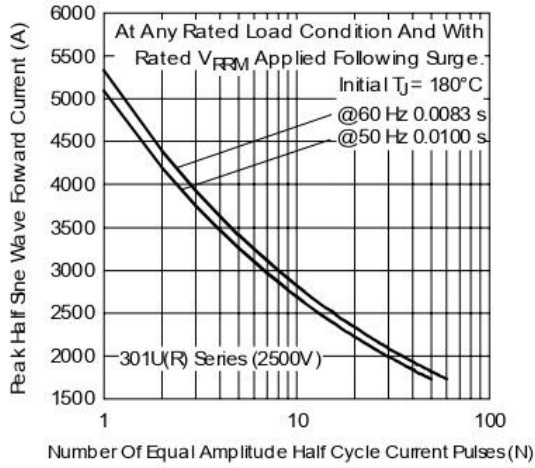

Fig. 11 - Maximum Non-Repetitive Surge Current

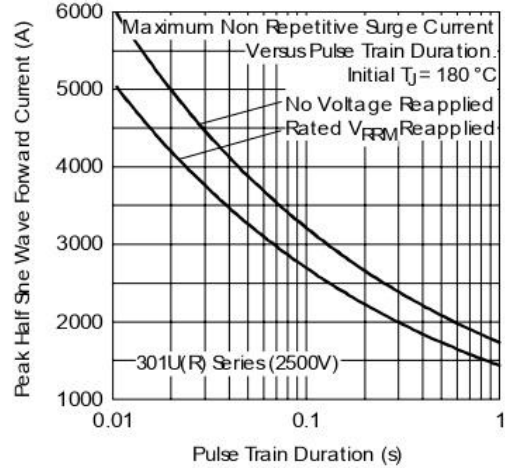

Fig. 12 - Maximum Non-Repetitive Surge Current

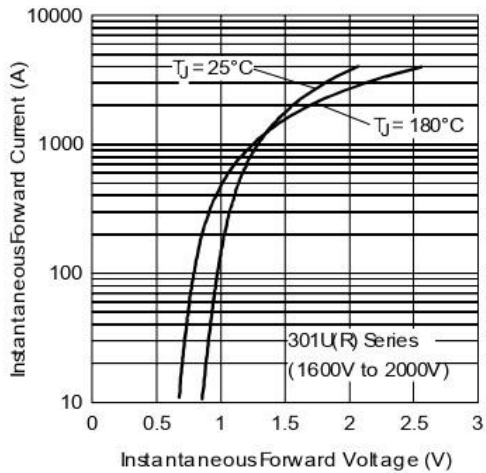

Fig. 13 - Forward Voltage Drop Characteristics

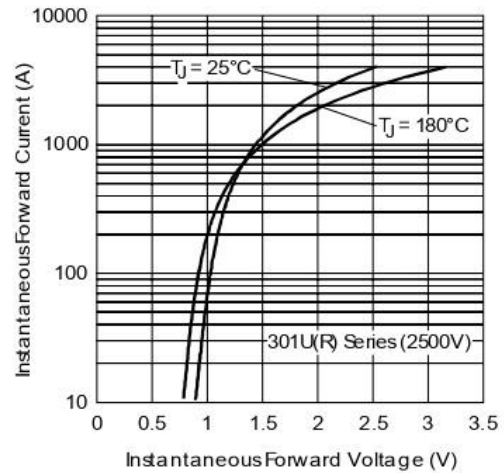

Fig. 14 - Forward Voltage Drop Characteristics

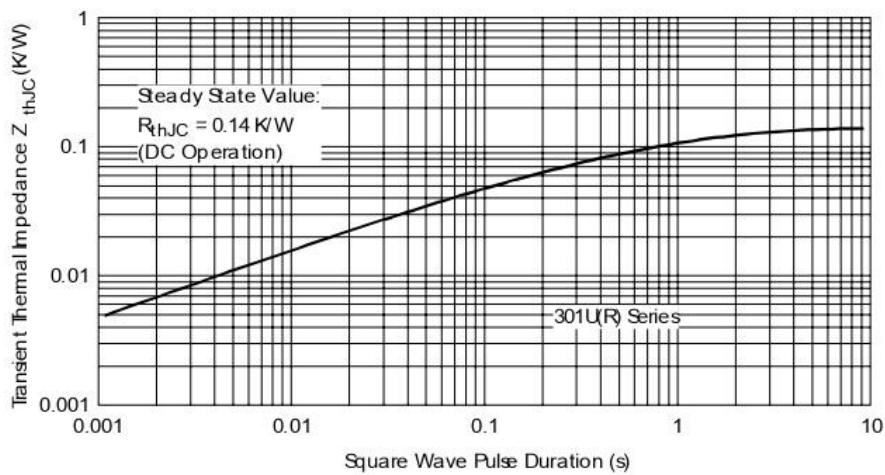

Fig. 15 - Thermal Impedance Z_{thJC} Characteristic

Data and specifications subject to change without notice.
This product has been designed and qualified for Industrial Level.
Qualification Standards can be found on IR's Web site.

International
IOR Rectifier

IR WORLD HEADQUARTERS: 233 Kansas St., El Segundo, California 90245, USA Tel: (310) 252-7105
TAC Fax: (310) 252-7309
Visit us at www.irf.com for sales contact information. 03/03

www.irf.com

Notes on Drawings

[Insert here a list of Drawings, including site plans, which should be attached to this section or annexed in a separate folder. The Drawings shall be clearly dated, numbered and show any revision number(s), if appropriate.]

Not For Submission